

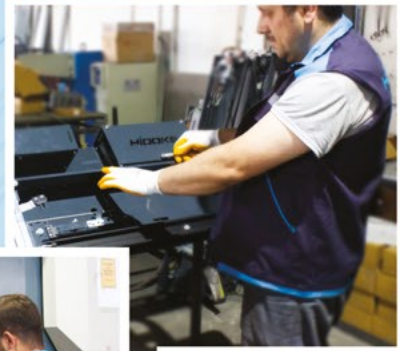

ÜRÜN KATALOĞU
PRODUCT CATALOGUE

teknolojinin yükselişi

HIDOKS[®]
ASANSÖR



www.hidoks.com.tr

İÇİNDEKİLER / INDEX / СОДЕРЖАНИЕ / الفهرس

- 02 **SERTİFİKALAR**
OUR CERTIFICATES
СЕРТИФИКАТЫ
شهاداتا
- 03 **FİRMA PROFİLİ**
ABOUT US
ПРОФИЛЬ КОМПАНИИ
عن الشركة
- 04-05 **İHRACAT**
EXPORT
ЭКСПОРТ
تصدير
- 06-07 **İŞ ORTAKLARIMIZ**
OUR PARTNERS
НАШИ ДЕЛОВЫЕ ПАРТНЕРЫ
شركاؤنا
- 11-42 **KABİNLER**
CABINES
КАБИНЫ
الكبائن
- 43 **SAM GÖRSELLER**
GLASS OPTIONS
СТЕКЛЯННЫЕ ИЗОБРАЖЕНИЯ
خيارات الزجاج
- 44 **PANORAMİK KABİNLER**
PANORAMIC CABINS
ГРИБ ПАНОРАМНЫЙ
كبائن بانوراما
- 45 **TAVANLAR**
CEILINGS
ПОТОЛОК
خيارات السقفيات
- 46 **PASLANMAZLAR**
STAINLESS STEEL OPTIONS
ОТДЕЛКИ
خيارات الستانلس
- 47 **TABANLAR**
FLOOR OPTIONS
ПОЛЫ
الأرضيات
- 49 **PANOLAR**
CONTROL PANELS
СИСТЕМА УПРАВЛЕНИЯ
الكوتترولات
- 51 **ÇARPMA KAPILAR**
MANUAL DOORS
ПОЛУАВТОМАТИЧЕСКИЕ ДВЕРИ
أبواب نصف أوتوماتيكية
- 53-61 **OTOMATİK KAPILAR**
AUTOMATIC DOORS
АВТОМАТИЧЕСКИЕ ДВЕРИ
أبواب أوتوماتيكية
- 63-65 **MAKİNE MOTORLAR**
TRACTION MACHINES
ЛЕБЕДКИ
المحركات
- 66-67 **EV ASANSÖRÜ**
HOMELIFT
ДОМАШНИЙ ЛИФТ
مصاعد منزلية (هوم ليفت)
- 68-71 **PLATFORMLAR**
OPEN PLATFORMS
ПЛАТФОРМ
مصاعد مفتوحة (بلاتفورم)
- 72 **MAKİNE DAİRELİ SİSTEMLER**
MACHINE ROOM SYSTEM (MR)
СИСТЕМЫ МАШИНОСТРОЕНИЯ
مصاعد بغرفة للمحرك
- 73 **MAKİNE DAİRESİZ SİSTEMLER**
MACHINE ROOMLESS SYSTEM (MRL)
СИСТЕМЫ БЕЗ МАШИН
مصاعد بدون غرفة للمحرك (روملس)
- 74-77 **SİSTEMLER**
SUSPENTION TYPES
ШАХТА
أنظمة التعليق
- 79-83 **BUTONLAR**
OPERATING PANELS
ПЕРИФЕРИЙНАЯ АППАРАТУРА
لوحات الطلب
- 84-87 **ASANSÖR ÖLÇÜLERİ**
ELEVATOR DIMENSIONS
ЧЕРТЕЖИ
أبعاد المصعد
- 88 **ASANSÖR TALEP FORMU**
INQUIRY FORM
ФОРМА ЗАПРОСА ЛИФТА
نموذج طلب





HAKKIMIZDA

Hidoks Asansör gerekli her türlü eğitim ve donanımına sahip geniş kadrosuyla üretim, montaj, periyodik bakım, onarım ve servis faaliyetlerini sürdürmektedir. Kusursuz müşteri memnuniyeti ilkesi ile faaliyetini sürdüren firmamız; imalat, montaj, bakım, proje konularında kalite, performans uygun fiyat ve dünya standartları ölçülerine göre çalışmalarını sürdürmekte ve hedeflediği müşteri potansiyeline ulaşmaktadır. Satış ve teslimat sonrası periyodik bakım hizmetleri yanında verdiği garanti güvencesiyle müşteri memnuniyetine de güç katmaya devam etmektedir. Hidoks Asansör kalitesi, araştırmacılığı, gelişen dünyayı ve teknolojiyi esas alarak yarınlara emin adımlarla ilerlemektedir.

ABOUT US

HIDOKS is one of the most prestigious and pioneer companies in Turkey with long work experience in the field of manufacturing elevators of all kinds, with full compliance with all applicable international standards. The company also carries out all installation and maintenance work inside Turkey and in all around the world. With our long experience and distinguished cadres who are trained on all tasks, we perform all our work with one goal: the satisfaction of our customers and their permanent happiness with our distinguished services with complete safety. We strive to be the best always by keeping pace with the latest global technologies and making use of all modern tools in order to always produce the best. Your satisfaction and the safety of your families is our first and last goal.

О КОМПАНИИ

Компания «Hidoks Asansör» вместе со своим большим штатом сотрудников, обладающих необходимыми знаниями, квалификацией и опытом, продолжает функционировать, предоставляя услуги в области производства, монтажа, периодического технического обслуживания, ремонта и сервисного обслуживания. Осуществляющая свою деятельность по принципу полноценного удовлетворения потребностей клиентов, наша компания продолжает заниматься производством, монтажной сборкой, обслуживанием, вопросами проекта в соответствии с качеством, производительностью, доступными ценами и мировыми стандартами, стремясь к достижению своего целевого клиентского потенциала. Компания продолжает повышать удовлетворенность клиентов за счет предоставления гарантий вместе с проведением качественного периодического технического обслуживания после продажи и доставки. Компания «Hidoks Asansör» уверенными шагами стремительно направляется в завтрашний день, основываясь на качество, исследования, развивающийся мир и современные технологии.

معلومات عنا

شركة هيدوكس هي واحدة من الشركات العريقة في تركيا و بخبرة عمل طويلة في مجال صناعة المصاعد بكافة أنواعها مع مطابقتها الكاملة لكل المعايير العالمية المعمول بها . كما أن الشركة تقوم بكافة أعمال التركيب و الصيانة داخل تركيا و في كافة أرجاء العالم . بخبرتنا الطويلة و كوادرننا المميزة و المدربة على كافة المهام نقوم بأداء جميع أعمالنا بهدف واحد ألا و هو رضا عملائنا و سعادتهم الدائمة بخدماطنا المميزة بأمان كامل. نسعى بأن نكون الأفضل دائما و ذلك بمواكبة آخر التقنيات العالمية و الاستفادة من كل الأدوات الحديثة وذلك لانتاج الأفضل دائما. رضاؤكم و أمان أسركم هو هدفنا الأول و الأخير .

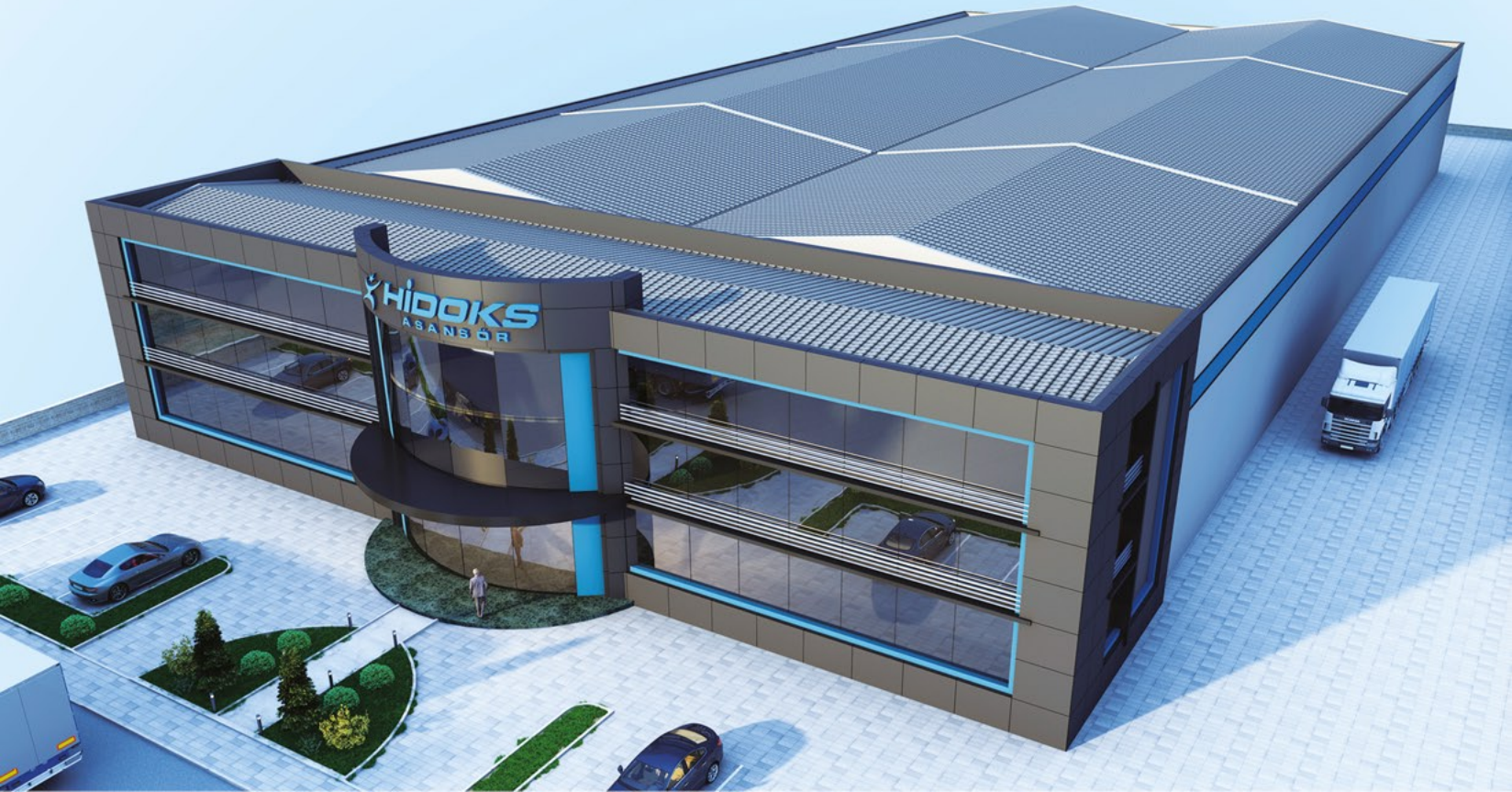

HIDOKS®

ASANSÖR

 Meksika	 Senegal	 Kenya	 Fas	 Yemen
 Venezuela	 Gana	 Libya	 Cezayir	 Umman
 Kolombiya	 Nijerya	 Etiyopya	 Somali	 Katar
 Peru	 Kamerun	 Sudan	 Ürdün	 Suudi Arabistan
 Brezilya	 Güney Afrika	 Mısır	 Irak	 B.A.E
 Arjantin	 Tanzanya	 Libya	 Suriye	 İran
 Kostarika	 Uganda	 Tunus	 Lübnan	 Azerbaycan



 Afganistan	 Moğolistan	 Almanya	 Hırvatistan	 Polonya
 Pakistan	 Rusya	 Fransa	 Çekya	 Moldova
 Türkmenistan	 Endonezya	 İtalya	 Makedonya	 Ukrayna
 Kırgızistan	 Tayland	 İspanya	 Arnavutluk	 Romanya
 Kazakistan	 Bangladeş	 Portekiz	 Bosna Hersek	 Bulgaristan
 Özbekistan	 Hindistan	 İngiltere	 Slovakya	 Belarus
 Tacikistan	 Vietnam	 Avusturya	 Litvanya	 Estonya





İŞ ORTAKLARIMIZ
OUR PARTNERS
НАШИ ДЕЛОВЫЕ ПАРТНЕРЫ
شركاؤنا



Beha Yapı



İŞ ORTAKLARIMIZ
OUR PARTNERS
НАШИ ДЕЛОВЫЕ ПАРТНЕРЫ
شرکائونا



AltınSUR
YAPI MİMARLIK
YAPILAR SAN. VE TİC. LTD. ŞTİ.

AKM YAPI

aktif
yapı

AKTUNA
İNŞAAT

ALI DİLEK
İNŞAAT

BEY
— mimarlık —

BOLAY İNŞAAT

Buldukhān.
İNŞAAT LTD. ŞTİ.

CAMPLAZA

DADAŞOĞLU
İNŞAAT

Can Site



GÜÇAR
İNŞAAT SAN. VE TİC. A.Ş.

GÜMÜŞHAN
İNŞAAT

HİDAYET BAYSAK
Gayrimenkul & İnşaat

KONYA HUGLU
YAPI VE İNŞAAT MÜHÜRÜ SAN. VE TİC. LTD. ŞTİ.

KIZILOZ
İNŞAAT LTD. ŞTİ.

KOMYAPI

koneSSA
yapısal emlak organizasyonu

KONPROJE

konyaşeker

İNCI
KONAKLARI

SADEMUSTA

SUDE
MİMARLIK

TMS
YAPI

ÜÇGEN
MİMARLIK
İNŞAAT

MASIRYAPI
Mühendislik Mimari Sanayi Tic. Ltd. Şti.

ÖZCAN
İNŞAAT
1969

ÖZ CERAN
İNŞAAT

ÖZDEMİR
İNŞAAT

Öztekinler
inşaat

İİPM²⁵⁺
PİNAR MÜHENDİSLİK SAN. VE TİC. LTD. ŞTİ.



SENA
İNŞAAT VE MAKİNA TİC. LTD. ŞTİ.

SGK
MİMARLIK GÜVENLİK VE KURUM
BURDUR

Süleyman DEMİR inş.

TALEB
inşaat

TEPEKENT
mimarlık

YALÇINLAR
İNŞAAT

Yamanlar

YANAL
MÜHENDİSLİK

YAPALI
mühendislik

YEN-KO
İNŞAAT İHR. İTH. PAZ. VE TİC. A.Ş.

AZRA YAPI

PARK YAPI
www.parkyapimimarlik.com

SANER
İNŞAAT A.Ş.

SELÇUK ÜNİVERSİTESİ
KONYA - 1975

KORKMAZ BEY

REVIZYON
REVISION
PEMOHT
مراجعة

HIDOKS
ASANSÖR

REVIZYON
REVISION
PEMOHT
مراجعة

ÜRETİM
PRODUCTION
ПРОИЗВОДСТВО
إنتاج

MONTAJ
ASSEMBLY
МОНТАЖ
المجسم

HIDOKS
ASANSÖR

HIDOKS
ASANSÖR

MONTAJ
ASSEMBLY
МОНТАЖ
المجسم

REVIZYON
REVISION
PEMOHT
مراجعة

ÜRETİM
PRODUCTION
ПРОИЗВОДСТВО

MONTAJ
ASSEMBLY
МОНТАЖ

HIDOKS
ASANSÖR



ÜRETİM
PRODUCT
ПРОИЗВОДСТВО
إنتاج

HIDOKS
ASANSÖR

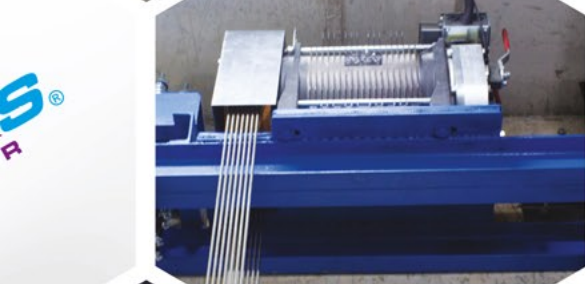

ÜRETİM
PRODUCT
ПРОИЗВОДСТВО
إنتاج



HIDOKS
ASANSÖR



HIDOKS
ASANSÖR

REVİZYON
REVISION
РЕМОНТ
مراجعة



HIDOKS
ASANSÖR



ÜRETİM
PRODUCTION
ПРОИЗВОДСТВО
إنتاج

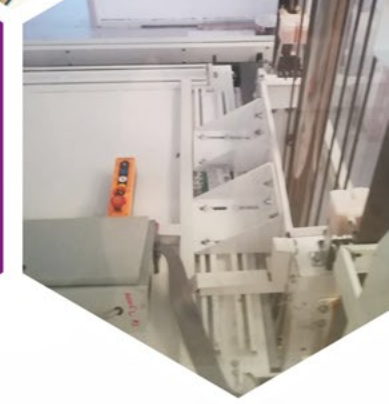

REVİZYON
REVISION
РЕМОНТ
مراجعة

REVİZYON
REVISION
РЕМОНТ
مراجعة

HIDOKS
ASANSÖR

HIDOKS
ASANSÖR



KABINLER
CABINES / КАБИНЫ
الكبائن



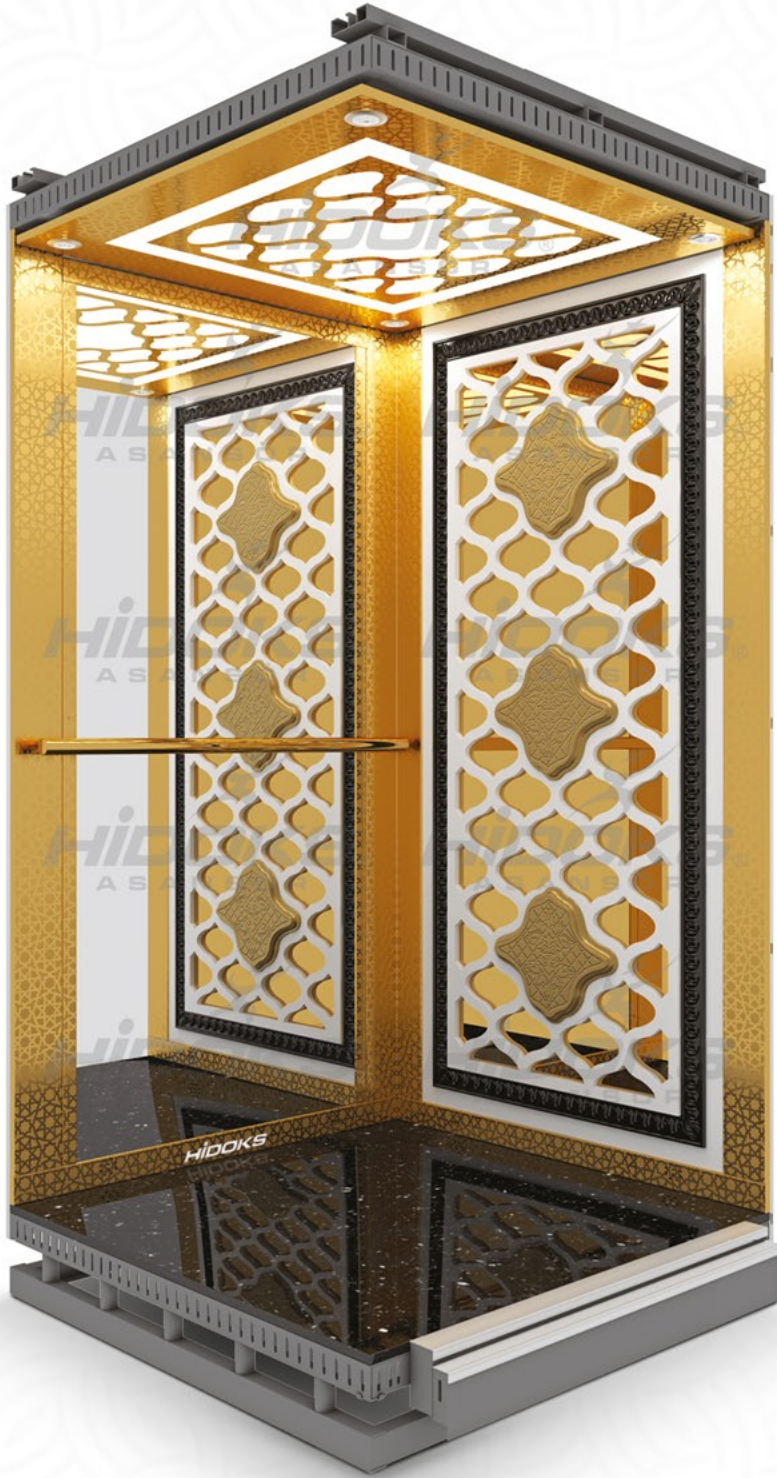

Kaplama : 1,5mm galvanizli sac (304 kalite)

Cabin Walls : 1.5 mm galvanized sheet (304 quality) with multiple interior designs.

Покрытие : Оцинкованный лист толщиной 1,5 мм (качество 304)

حوائط الكابينة : صاج 1.5 مم مجلفن (جودة 304) بتصميمات داخلية متعددة

Tavan : Lazer tavan. Cam ve led seçeneği mevcuttur.

Ceiling : Multiple designs designed by laser.

Потолок : Лазерный потолок. Опционально доступны варианты со стеклом и светодиодами.

السقف : تصميمات متعددة منقوشة بالليزر

Taban : 30 mm. Doğal granit

Floor : 30 mm. Natural granite

Основание : 30 мм. Основание из натурального гранита

الأرضية : 30 ملم جرانيت طبيعي

Özellikler / Propertis / Характеристики / المواصفات

Çalıştırılmaya hazır aydınlatma ve fan.
Kabinlerimizde kayma fren standardı mevcuttur.

Equipped with lighting and ventilation systems.
Special fixing to prevent vibration.

В наших кабинах, оснащенных готовыми к работе освещением и вентилятором, имеются стандартные тормоза скольжения

مجھزة بأنظمة الانارة و التهوية.
قواعد تثبيت خاصة لمنع الاهتزاز.

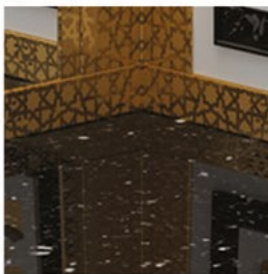

ÜRÜN KODU
PRODUCT CODE**HD 002**

Kaplama : 1,5mm galvanizli sac (304 kalite)
Cabin Walls : 1.5 mm galvanized sheet (304 quality) with multiple interior designs.
Покрытие : Оцинкованный лист толщиной 1,5 мм (качество 304)
حوائط الكابينة : صاج 1.5 مم مجلفن (جودة 304) بتصميمات داخلية متعددة

Tavan : Lazer tavan. Cam ve led seçeneği mevcuttur.
Ceiling : Multiple designs designed by laser.
Потолок : Лазерный потолок. Опционально доступны варианты со стеклом и светодиодами.
السقف : تصميمات متعددة منقوشة بالليزر

Taban : 30 mm. Doğal granit
Floor : 30 mm. Natural granite
Основание : 30 мм. Основание из натурального гранита
الأرضية : 30 ملم جرانيت طبيعي

Özellikler / Propertis / Характеристики / المواصفات

Çalıştırılmaya hazır aydınlatma ve fan.
Kabinlerimizde kayma fren standartı mevcuttur.

Equipped with lighting and ventilation systems.
Special fixing to prevent vibration.

В наших кабинах, оснащенных готовыми к работе освещением и вентилятором, имеются стандартные тормоза скольжения

مجھزة بأنظمة الاثارة و التهوية.
قواعد تثبيت خاصة لمنع الاهتزاز.





Kaplama : 1,5mm galvanizli sac (304 kalite)

Cabin Walls : 1.5 mm galvanized sheet (304 quality) with multiple interior designs.

Покрытие : Оцинкованный лист толщиной 1,5 мм (качество 304)

حوائط الكابينة : صاج 1.5 مم مجلفن (جودة 304) بتصميمات داخلية متعددة

Tavan : Lazer tavan. Cam ve led seçeneği mevcuttur.

Ceiling : Multiple designs designed by laser.

Потолок : Лазерный потолок. Опционально доступны варианты со стеклом и светодиодами.

السقف : تصميمات متعددة منقوشة بالليزر

Taban : 30 mm. Doğal granit

Floor : 30 mm. Natural granite

Основание : 30 мм. Основание из натурального гранита

الأرضية : 30 ملم جرانيت طبيعي

Özellikler / Propertis / Характеристики / المواصفات

Çalıştırılmaya hazır aydınlatma ve fan.
Kabinlerimizde kayma fren standardı mevcuttur.

Equipped with lighting and ventilation systems.
Special fixing to prevent vibration.

В наших кабинах, оснащенных готовыми к работе освещением и вентилятором, имеются стандартные тормоза скольжения

مجھزة بأنظمة الانارة و التهوية.
قواعد تثبيت خاصة لمنع الاهتزاز.

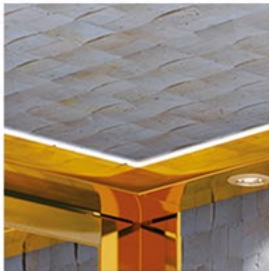

**ÜRÜN KODU
PRODUCT CODE****HD 004****Kaplama** : 1,5mm galvanizli sac (304 kalite)**Cabin Walls** : 1.5 mm galvanized sheet (304 quality) with multiple interior designs.**Покрытие** : Оцинкованный лист толщиной 1,5 мм (качество 304)**حوائط الكابينة** : صاج 1.5 مم مجلفن (جودة 304) بتصميمات داخلية متعددة**Tavan** : Lazer tavan. Cam ve led seçeneği mevcuttur.**Ceiling** : Multiple designs designed by laser.**Потолок** : Лазерный потолок. Опционально доступны варианты со стеклом и светодиодами.**السقف** : تصميمات متعددة منقوشة بالليزر**Taban** : 30 mm. Doğal granit**Floor** : 30 mm. Natural granite**Основание** : 30 мм. Основание из натурального гранита**الأرضية** : 30 ملم جرانيت طبيعي**Özellikler / Propertis / Характеристики / المواصفات**

Çalıştırılmaya hazır aydınlatma ve fan.
Kabinlerimizde kayma fren standartı mevcuttur.

Equipped with lighting and ventilation systems.
Special fixing to prevent vibration.

В наших кабинах, оснащенных готовыми к работе освещением и вентилятором, имеются стандартные тормоза скольжения

مجھزة بأنظمة الانارة و التهوية.
قواعد تثبيت خاصة لمنع الاهتزاز.

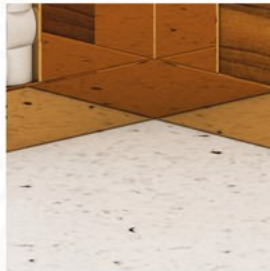
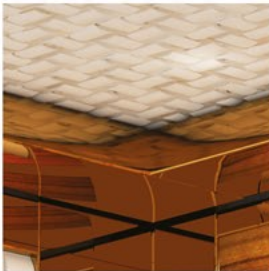



Kaplama : 1,5mm galvanizli sac (304 kalite)

Cabin Walls : 1.5 mm galvanized sheet (304 quality) with multiple interior designs.

Покрытие : Оцинкованный лист толщиной 1,5 мм (качество 304)

حوائط الكابينة : صاج 1.5 مم مجلفن (جودة 304) بتصميمات داخلية متعددة

Tavan : Lazer tavan. Cam ve led seçeneği mevcuttur.

Ceiling : Multiple designs designed by laser.

Потолок : Лазерный потолок. Опционально доступны варианты со стеклом и светодиодами.

السقف : تصميمات متعددة منقوشة بالليزر

Taban : 30 mm. Doğal granit

Floor : 30 mm. Natural granite

Основание : 30 мм. Основание из натурального гранита

الأرضية : 30 ملم جرانيت طبيعي

Özellikler / Propertis / Характеристики / المواصفات

Çalıştırılmaya hazır aydınlatma ve fan.
Kabinlerimizde kayma fren standardı mevcuttur.

Equipped with lighting and ventilation systems.
Special fixing to prevent vibration.

В наших кабинах, оснащенных готовыми к работе освещением и вентилятором, имеются стандартные тормоза скольжения

مجهزة بأنظمة الانارة و التهوية.
قواعد تثبيت خاصة لمنع الاهتزاز.

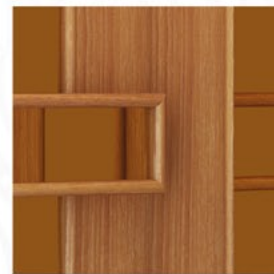

**ÜRÜN KODU
PRODUCT CODE****HD 006****Kaplama** : 1,5mm galvanizli sac (304 kalite)**Cabin Walls** : 1.5 mm galvanized sheet (304 quality) with multiple interior designs.**Покрытие** : Оцинкованный лист толщиной 1,5 мм (качество 304)**حوائط الكابينة** : صاج 1.5 مم مجلفن (جودة 304) بتصميمات داخلية متعددة**Tavan** : Lazer tavan. Cam ve led seçeneği mevcuttur.**Ceiling** : Multiple designs designed by laser.**Потолок** : Лазерный потолок. Опционально доступны варианты со стеклом и светодиодами.**السقف** : تصميمات متعددة منقوشة بالليزر**Taban** : 30 mm. Doğal granit**Floor** : 30 mm. Natural granite**Основание** : 30 мм. Основание из натурального гранита**الأرضية** : 30 ملم جرانيت طبيعي**Özellikler / Propertis / Характеристики / المواصفات**

Çalıştırılmaya hazır aydınlatma ve fan.
Kabinlerimizde kayma fren standartı mevcuttur.

Equipped with lighting and ventilation systems.
Special fixing to prevent vibration.

В наших кабинах, оснащенных готовыми к работе освещением и вентилятором, имеются стандартные тормоза скольжения

مجہزہ بأنظمة الاضاءة و التهوية.
قواعد تثبيت خاصة لمنع الاهتزاز.

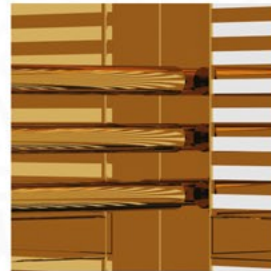
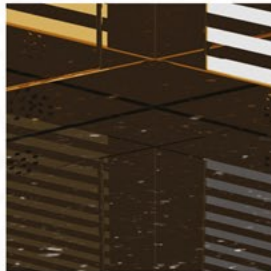
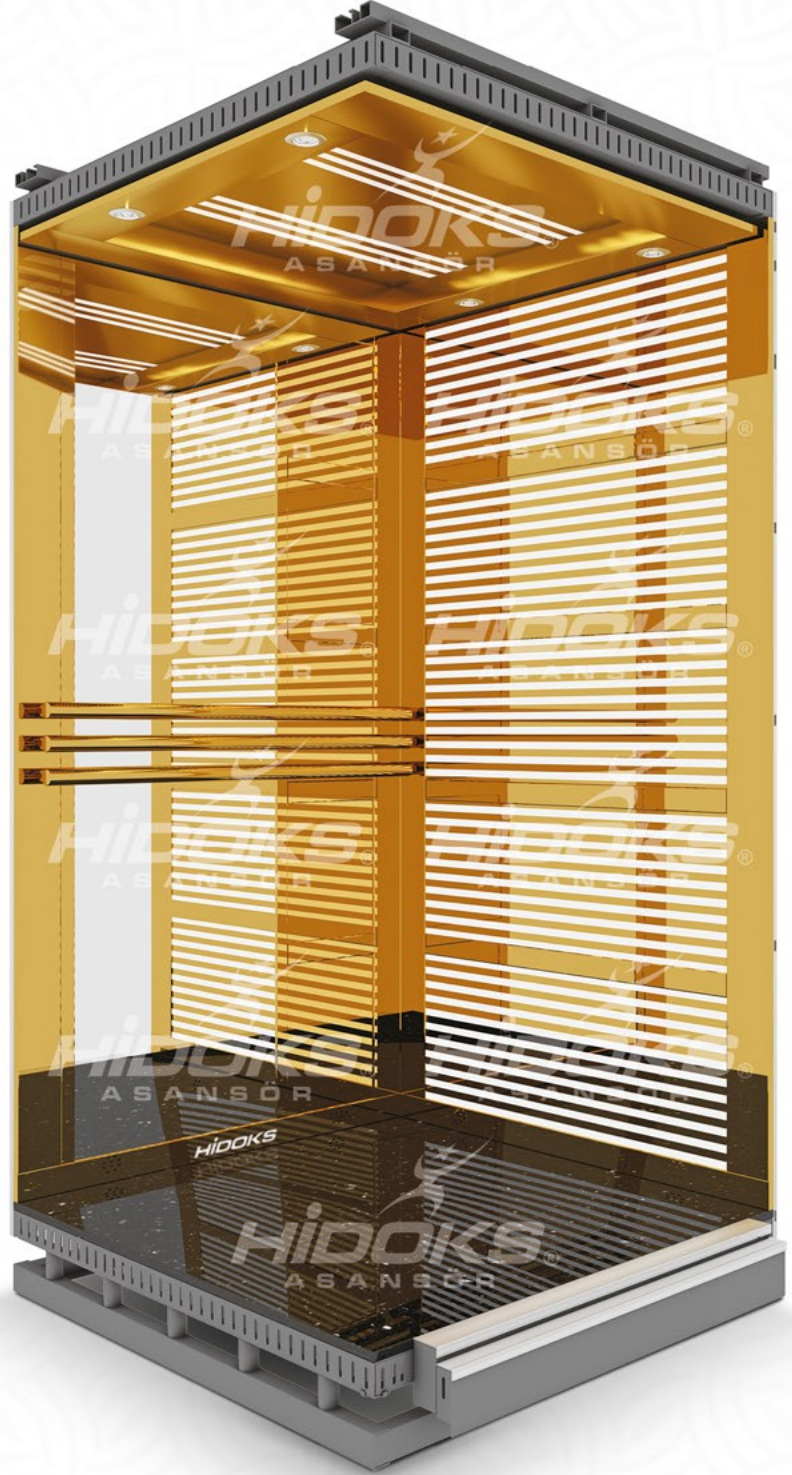



Kaplama : 1,5mm galvanizli sac (304 kalite)

Cabin Walls : 1.5 mm galvanized sheet (304 quality) with multiple interior designs.

Покрытие : Оцинкованный лист толщиной 1,5 мм (качество 304)

حوائط الكابينة : صاج 1.5 مم مجلفن (جودة 304) بتصميمات داخلية متعددة

Tavan : Lazer tavan. Cam ve led seçeneği mevcuttur.

Ceiling : Multiple designs designed by laser.

Потолок : Лазерный потолок. Опционально доступны варианты со стеклом и светодиодами.

السقف : تصميمات متعددة منقوشة بالليزر

Taban : 30 mm. Doğal granit

Floor : 30 mm. Natural granite

Основание : 30 мм. Основание из натурального гранита

الأرضية : 30 ملم جرانيت طبيعي

Özellikler / Propertis / Характеристики / المواصفات

Çalıştırılmaya hazır aydınlatma ve fan.
Kabinlerimizde kayma fren standardı mevcuttur.

Equipped with lighting and ventilation systems.
Special fixing to prevent vibration.

В наших кабинах, оснащенных готовыми к работе освещением и вентилятором, имеются стандартные тормоза скольжения

مجھزة بأنظمة الانارة و التهوية.
قواعد تثبيت خاصة لمنع الاهتزاز.

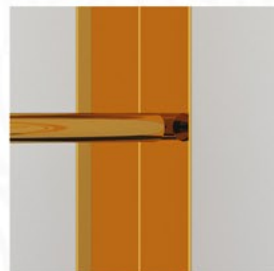
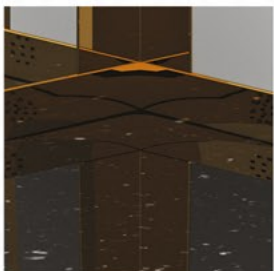

**ÜRÜN KODU
PRODUCT CODE****HD 008**

Kaplama : 1,5mm galvanizli sac (304 kalite)
Cabin Walls : 1.5 mm galvanized sheet (304 quality) with multiple interior designs.
Покрытие : Оцинкованный лист толщиной 1,5 мм (качество 304)
حوائط الكابينة : صاج 1.5 مم مجلفن (جودة 304) بتصميمات داخلية متعددة

Tavan : Lazer tavan. Cam ve led seçeneği mevcuttur.
Ceiling : Multiple designs designed by laser.
Потолок : Лазерный потолок. Опционально доступны варианты со стеклом и светодиодами.
السقف : تصميمات متعددة منقوشة بالليزر

Taban : 30 mm. Doğal granit
Floor : 30 mm. Natural granite
Основание : 30 мм. Основание из натурального гранита
الأرضية : 30 ملم جرانيت طبيعي

Özellikler / Propertis / Характеристики / المواصفات

Çalıştırılmaya hazır aydınlatma ve fan.
Kabinlerimizde kayma fren standardı mevcuttur.

Equipped with lighting and ventilation systems.
Special fixing to prevent vibration.

В наших кабинах, оснащенных готовыми к работе освещением и вентилятором, имеются стандартные тормоза скольжения

مجہزہ بأنظمة الانارة و التهوية.
قواعد تثبيت خاصة لمنع الاهتزاز.





Kaplama : 1,5mm galvanizli sac (304 kalite)

Cabin Walls : 1.5 mm galvanized sheet (304 quality) with multiple interior designs.

Покрытие : Оцинкованный лист толщиной 1,5 мм (качество 304)

حوائط الكابينة : صاج 1.5 مم مجلفن (جودة 304) بتصميمات داخلية متعددة

Tavan : Lazer tavan. Cam ve led seçeneği mevcuttur.

Ceiling : Multiple designs designed by laser.

Потолок : Лазерный потолок. Опционально доступны варианты со стеклом и светодиодами.

السقف : تصميمات متعددة منقوشة بالليزر

Taban : 30 mm. Doğal granit

Floor : 30 mm. Natural granite

Основание : 30 мм. Основание из натурального гранита

الأرضية : 30 ملم جرانيت طبيعي

Özellikler / Propertis / Характеристики / المواصفات

Çalıştırılmaya hazır aydınlatma ve fan.
Kabinlerimizde kayma fren standardı mevcuttur.

Equipped with lighting and ventilation systems.
Special fixing to prevent vibration.

В наших кабинах, оснащенных готовыми к работе освещением и вентилятором, имеются стандартные тормоза скольжения

مجھزة بأنظمة الانارة و التهوية.
قواعد تثبيت خاصة لمنع الاهتزاز.



**ÜRÜN KODU
PRODUCT CODE****HD 010****Kaplama** : Laminant (18mm radüslü)**Cabin Walls** : Laminate (18mm. radius)**Покрытие** : покрытие из ламината**حوائط الكابينة** : سماكة 18 مم**Tavan** : Lazer tavan. Cam ve led seçeneği mevcuttur.**Ceiling** : Multiple designs designed by laser .**Потолок** : Лазерный потолок. Опционально доступны варианты со стеклом и светодиодами.**السقف** : تصميمات متعددة منقوشة بالليزر**Taban** : 30 mm. Doğal granit**Floor** : 30 mm. Natural granit**Основание** : 30 мм. Основание из натурального гранита**الأرضية** : 30 ملم جرانيت طبيعي**Özellikler / Propertis / Характеристики / المواصفات**

Çalıştırılmaya hazır aydınlatma ve fan.
Kabinlerimizde kayma fren standartı mevcuttur.

Equipped with lighting and ventilation systems.
Special fixing to prevent vibration.

В наших кбинах, оснащенных готовыми к работе освещением и вентилятором, имеются стандартные тормоза скольжения

مجھزة بأنظمة الانارة و التهوية.
قواعد تثبيت خاصة لمنع الاهتزاز.

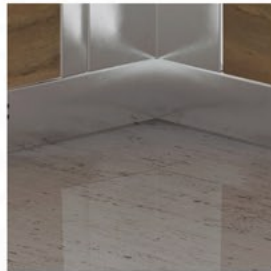



Kaplama : Cam görsel uygulaması

Cabin Walls : Glass visual application

Покрытие : применение визуального стекла

حوائط الكابينة : تطبيق بصري زجاجي

Tavan : Lazer tavan. Cam ve led seçeneği mevcuttur.

Ceiling : Multiple designs designed by laser.

Потолок : Лазерный потолок. Опционально доступны варианты со стеклом и светодиодами.

السقف : تصميمات متعددة منقوشة بالليزر

Taban : 30 mm. Doğal granit

Floor : 30 mm. Natural granite

Основание : 30 мм. Основание из натурального гранита

الأرضية : 30 ملم جرانيت طبيعي

Özellikler / Propertis / Характеристики / المواصفات

Çalıştırılmaya hazır aydınlatma ve fan.

Kabinlerimizde kayma fren standardı mevcuttur.

Equipped with lighting and ventilation systems.

Special fixing to prevent vibration.

В наших кабинах, оснащенных готовыми к работе освещением и вентилятором, имеются стандартные тормоза скольжения

مجھزة بأنظمة الانارة و التهوية.
قواعد تثبيت خاصة لمنع الاهتزاز.

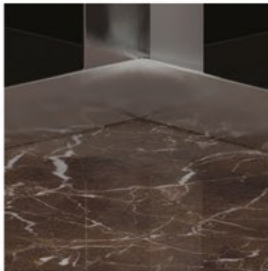

**ÜRÜN KODU
PRODUCT CODE****HD 012****Kaplama** : 1,5mm galvanizli sac (304 kalite)**Cabin Walls** : 1.5 mm galvanized sheet (304 quality) with multiple interior designs.**Покрытие** : Оцинкованный лист толщиной 1,5 мм (качество 304)**حوائط الكابينة** : صاج 1.5 مم مجلفن (جودة 304) بتصميمات داخلية متعددة**Tavan** : Lazer tavan. Cam ve led seçeneği mevcuttur.**Ceiling** : Multiple designs designed by laser.**Потолок** : Лазерный потолок. Опционально доступны варианты со стеклом и светодиодами.**السقف** : تصميمات متعددة منقوشة بالليزر**Taban** : 30 mm. Doğal granit**Floor** : 30 mm. Natural granite**Основание** : 30 мм. Основание из натурального гранита**الأرضية** : 30 ملم جرانيت طبيعي**Özellikler / Propertis / Характеристики / المواصفات**

Çalıştırılmaya hazır aydınlatma ve fan.
Kabinlerimizde kayma fren standartı mevcuttur.

Equipped with lighting and ventilation systems.
Special fixing to prevent vibration.

В наших кабинах, оснащенных готовыми к работе освещением и вентилятором, имеются стандартные тормоза скольжения

مجھزة بأنظمة الانارة و التهوية.
قواعد تثبيت خاصة لمنع الاهتزاز.

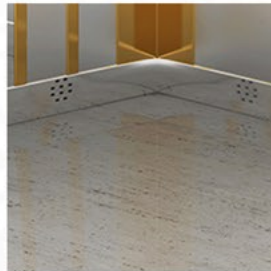

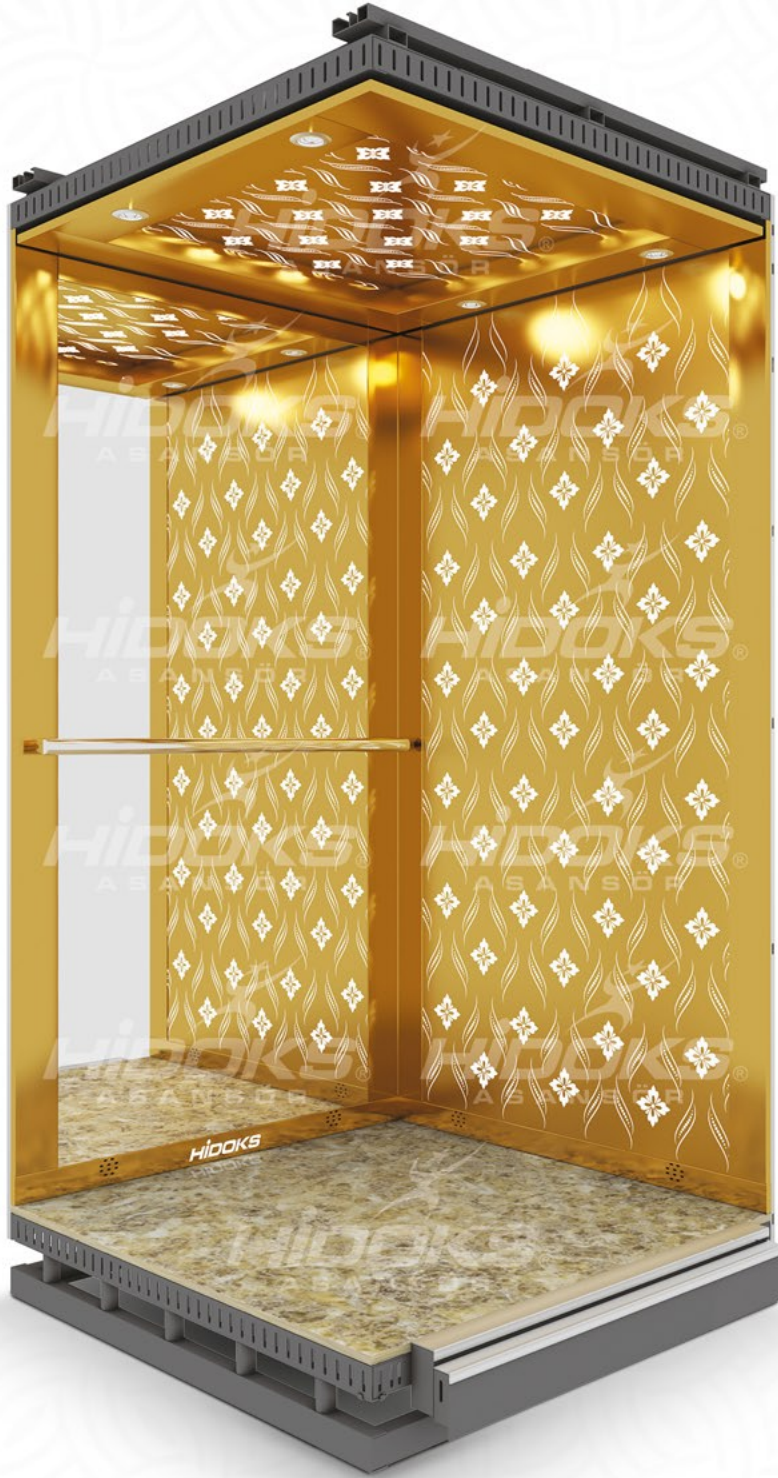

Kaplama : 1,5mm galvanizli sac (304 kalite)

Cabin Walls : 1.5 mm galvanized sheet (304 quality) with multiple interior designs.

Покрытие : Оцинкованный лист толщиной 1,5 мм (качество 304)

حوائط الكابينة : صاج 1.5 مم مجلفن (جودة 304) بتصميمات داخلية متعددة

Tavan : Lazer tavan. Cam ve led seçeneği mevcuttur.

Ceiling : Multiple designs designed by laser.

Потолок : Лазерный потолок. Опционально доступны варианты со стеклом и светодиодами.

السقف : تصميمات متعددة منقوشة بالليزر

Taban : 30 mm. Doğal granit

Floor : 30 mm. Natural granite

Основание : 30 мм. Основание из натурального гранита

الأرضية : 30 ملم جرانيت طبيعي

Özellikler / Propertis / Характеристики / المواصفات

Çalıştırılmaya hazır aydınlatma ve fan.
Kabinlerimizde kayma fren standartı mevcuttur.

Equipped with lighting and ventilation systems.
Special fixing to prevent vibration.

В наших кабинах, оснащенных готовыми к работе освещением и вентилятором, имеются стандартные тормоза скольжения

مجھزة بأنظمة الانارة و التهوية.
قواعد تثبيت خاصة لمنع الاهتزاز.

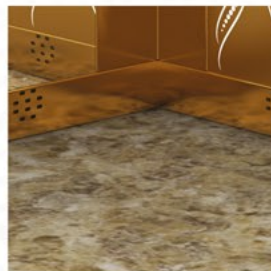

**ÜRÜN KODU
PRODUCT CODE****HD 014****Kaplama** : 1,5mm galvanizli sac (304 kalite)**Cabin Walls** : 1.5 mm galvanized sheet (304 quality) with multiple interior designs.**Покрытие** : Оцинкованный лист толщиной 1,5 мм (качество 304)**حوائط الكابينة** : صاج 1.5 مم مجلفن (جودة 304) بتصميمات داخلية متعددة**Tavan** : Lazer tavan. Cam ve led seçeneği mevcuttur.**Ceiling** : Multiple designs designed by laser.**Потолок** : Лазерный потолок. Опционально доступны варианты со стеклом и светодиодами.**السقف** : تصميمات متعددة منقوشة بالليزر**Taban** : 30 mm. Doğal granit**Floor** : 30 mm. Natural granite**Основание** : 30 мм. Основание из натурального гранита**الأرضية** : 30 ملم جرانيت طبيعي**Özellikler / Propertis / Характеристики / المواصفات**

Çalıştırılmaya hazır aydınlatma ve fan.
Kabinlerimizde kayma fren standartı mevcuttur.

Equipped with lighting and ventilation systems.
Special fixing to prevent vibration.

В наших кабинах, оснащенных готовыми к работе освещением и вентилятором, имеются стандартные тормоза скольжения

مجہزہ بأنظمة الانارة و التهوية.
قواعد تثبيت خاصة لمنع الاهتزاز.





Kaplama : 1,5mm galvanizli sac (304 kalite)

Cabin Walls : 1.5 mm galvanized sheet (304 quality) with multiple interior designs.

Покрытие : Оцинкованный лист толщиной 1,5 мм (качество 304)

حوائط الكابينة : صاج 1.5 مم مجلفن (جودة 304) بتصميمات داخلية متعددة

Tavan : Lazer tavan. Cam ve led seçeneği mevcuttur.

Ceiling : Multiple designs designed by laser.

Потолок : Лазерный потолок. Опционально доступны варианты со стеклом и светодиодами.

السقف : تصميمات متعددة منقوشة بالليزر

Taban : 30 mm. Doğal granit

Floor : 30 mm. Natural granite

Основание : 30 мм. Основание из натурального гранита

الأرضية : 30 ملم جرانيت طبيعي

Özellikler / Propertis / Характеристики / المواصفات

Çalıştırılmaya hazır aydınlatma ve fan.
Kabinlerimizde kayma fren standardı mevcuttur.

Equipped with lighting and ventilation systems.
Special fixing to prevent vibration.

В наших кабинах, оснащенных готовыми к работе освещением и вентилятором, имеются стандартные тормоза скольжения

مجھزة بأنظمة الانارة و التهوية.
قواعد تثبيت خاصة لمنع الاهتزاز.

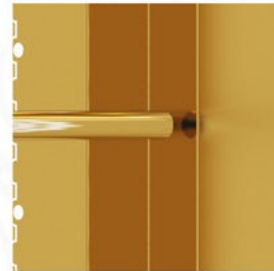
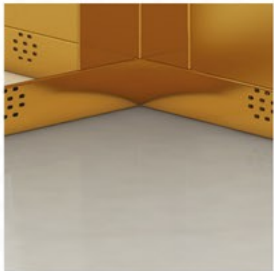
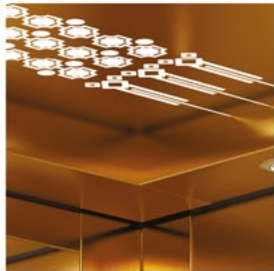

**ÜRÜN KODU
PRODUCT CODE****HD 016**

Kaplama : 1,5mm galvanizli sac (304 kalite)
Cabin Walls : 1.5 mm galvanized sheet (304 quality) with multiple interior designs.
Покрытие : Оцинкованный лист толщиной 1,5 мм (качество 304)
حوائط الكابينة : صاج 1.5 مم مجلفن (جودة 304) بتصميمات داخلية متعددة

Tavan : Lazer tavan. Cam ve led seçeneği mevcuttur.
Ceiling : Multiple designs designed by laser.
Потолок : Лазерный потолок. Опционально доступны варианты со стеклом и светодиодами.
السقف : تصميمات متعددة منقوشة بالليزر

Taban : 30 mm. Doğal granit
Floor : 30 mm. Natural granite
Основание : 30 мм. Основание из натурального гранита
الأرضية : 30 ملم جرانيت طبيعي

Özellikler / Propertis / Характеристики / المواصفات

Çalıştırılmaya hazır aydınlatma ve fan.
Kabinlerimizde kayma fren standartı mevcuttur.

Equipped with lighting and ventilation systems.
Special fixing to prevent vibration.

В наших кабинах, оснащенных готовыми к работе освещением и вентилятором, имеются стандартные тормоза скольжения

مجہزہ بأنظمة الانارة و التهوية.
قواعد تثبيت خاصة لمنع الاهتزاز.

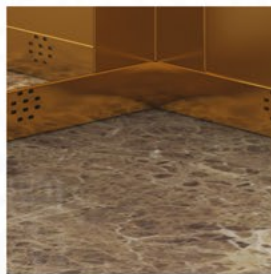



Kaplama : 1,5mm galvanizli sac (304 kalite)

Cabin Walls : 1.5 mm galvanized sheet (304 quality) with multiple interior designs.

Покрытие : Оцинкованный лист толщиной 1,5 мм (качество 304)

حوائط الكابينة : صاج 1.5 مم مجلفن (جودة 304) بتصميمات داخلية متعددة

Tavan : Lazer tavan. Cam ve led seçeneği mevcuttur.

Ceiling : Multiple designs designed by laser.

Потолок : Лазерный потолок. Опционально доступны варианты со стеклом и светодиодами.

السقف : تصميمات متعددة منقوشة بالليزر

Taban : 30 mm. Doğal granit

Floor : 30 mm. Natural granite

Основание : 30 мм. Основание из натурального гранита

الأرضية : 30 ملم جرانيت طبيعي

Özellikler / Propertis / Характеристики / المواصفات

Çalıştırılmaya hazır aydınlatma ve fan.

Kabinlerimizde kayma fren standardı mevcuttur.

Equipped with lighting and ventilation systems.

Special fixing to prevent vibration.

В наших кабинах, оснащенных готовыми к работе освещением и вентилятором, имеются стандартные тормоза скольжения

مجھزة بأنظمة الانارة و التهوية.
قواعد تثبيت خاصة لمنع الاهتزاز.



**ÜRÜN KODU
PRODUCT CODE****HD 018****Kaplama** : 1,5mm galvanizli sac (304 kalite)**Cabin Walls** : 1.5 mm galvanized sheet (304 quality) with multiple interior designs.**Покрытие** : Оцинкованный лист толщиной 1,5 мм (качество 304)**حوائط الكابينة** : صاج 1.5 مم مجلفن (جودة 304) بتصميمات داخلية متعددة**Tavan** : Lazer tavan. Cam ve led seçeneği mevcuttur.**Ceiling** : Multiple designs designed by laser.**Потолок** : Лазерный потолок. Опционально доступны варианты со стеклом и светодиодами.**السقف** : تصميمات متعددة منقوشة بالليزر**Taban** : 30 mm. Doğal granit**Floor** : 30 mm. Natural granite**Основание** : 30 мм. Основание из натурального гранита**الأرضية** : 30 ملم جرانيت طبيعي**Özellikler / Propertis / Характеристики / المواصفات**

Çalıştırılmaya hazır aydınlatma ve fan.
Kabinlerimizde kayma fren standartı mevcuttur.

Equipped with lighting and ventilation systems.
Special fixing to prevent vibration.

В наших кабинах, оснащенных готовыми к работе освещением и вентилятором, имеются стандартные тормоза скольжения

مجّهة بأنظمة الاثارة و التهوية.
قواعد تثبيت خاصة لمنع الاهتزاز.

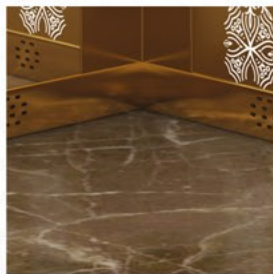



Kaplama : 1,5mm galvanizli sac (304 kalite)

Cabin Walls : 1.5 mm galvanized sheet (304 quality) with multiple interior designs.

Покрытие : Оцинкованный лист толщиной 1,5 мм (качество 304)

حوائط الكابينة : صاج 1.5 مم مجلفن (جودة 304) بتصميمات داخلية متعددة

Tavan : Lazer tavan. Cam ve led seçeneği mevcuttur.

Ceiling : Multiple designs designed by laser.

Потолок : Лазерный потолок. Опционально доступны варианты со стеклом и светодиодами.

السقف : تصميمات متعددة منقوشة بالليزر

Taban : 30 mm. Doğal granit

Floor : 30 mm. Natural granite

Основание : 30 мм. Основание из натурального гранита

الأرضية : 30 ملم جرانيت طبيعي

Özellikler / Propertis / Характеристики / المواصفات

Çalıştırılmaya hazır aydınlatma ve fan.
Kabinlerimizde kayma fren standardı mevcuttur.

Equipped with lighting and ventilation systems.
Special fixing to prevent vibration.

В наших кабинах, оснащенных готовыми к работе освещением и вентилятором, имеются стандартные тормоза скольжения

مجھزة بأنظمة الانارة و التهوية.
قواعد تثبيت خاصة لمنع الاهتزاز.

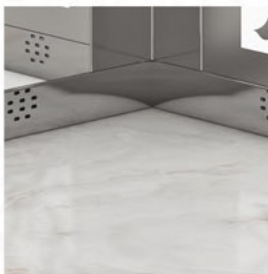

ÜRÜN KODU
PRODUCT CODE**HD 020****Kaplama** : Ahşap ve mermer**Cabin Walls** : Wood and marble**Покрытие** : Дерево и мрамор**حوائط الكابينة** : خشب و رخام**Tavan** : Lazer tavan. Cam ve led seçeneği mevcuttur.**Ceiling** : Multiple designs designed by laser.**Потолок** : Лазерный потолок. Опционально доступны варианты со стеклом и светодиодами.**السقف** : تصميمات متعددة منقوشة بالليزر**Taban** : 30 mm. Doğal granit**Floor** : 30 mm. Natural granite**Основание** : 30 мм. Основание из натурального гранита**الأرضية** : 30 ملم جرانيت طبيعي**Özellikler / Propertis / Характеристики / المواصفات**

Çalıştırılmaya hazır aydınlatma ve fan.

Kabinlerimizde kayma fren standardı mevcuttur.

Equipped with lighting and ventilation systems.
Special fixing to prevent vibration.

В наших кабинах, оснащенных готовыми к работе освещением и вентилятором, имеются стандартные тормоза скольжения

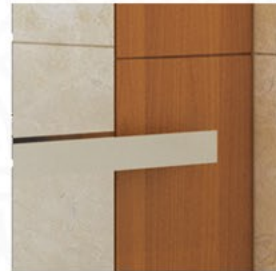
مجھة بأنظمة الانارة و التهوية.
قواعد تثبيت خاصة لمنع الاهتزاز.



Kaplama : 1,5mm galvanizli sac (304 kalite)

Cabin Walls : 1.5 mm galvanized sheet (304 quality) with multiple interior designs.

Покрытие : Оцинкованный лист толщиной 1,5 мм (качество 304)

حوائط الكابينة : صاج 1.5 مم مجلفن (جودة 304) بتصميمات داخلية متعددة

Tavan : Lazer tavan. Cam ve led seçeneği mevcuttur.

Ceiling : Multiple designs designed by laser.

Потолок : Лазерный потолок. Опционально доступны варианты со стеклом и светодиодами.

السقف : تصميمات متعددة منقوشة بالليزر

Taban : 30 mm. Doğal granit

Floor : 30 mm. Natural granite

Основание : 30 мм. Основание из натурального гранита

الأرضية : 30 ملم جرانيت طبيعي

Özellikler / Propertis / Характеристики / المواصفات

Çalıştırılmaya hazır aydınlatma ve fan.
Kabinlerimizde kayma fren standardı mevcuttur.

Equipped with lighting and ventilation systems.
Special fixing to prevent vibration.

В наших кабинах, оснащенных готовыми к работе освещением и вентилятором, имеются стандартные тормоза скольжения

مجهرة بأنظمة الاثارة و التهوية.
قواعد تثبيت خاصة لمنع الاهتزاز.

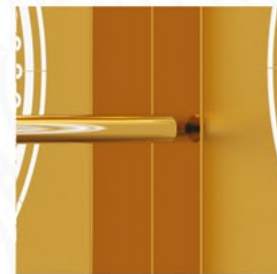
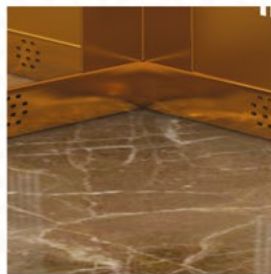

ÜRÜN KODU
PRODUCT CODE**HD 022****Kaplama** : 1,5mm galvanizli sac (304 kalite)**Cabin Walls** : 1.5 mm galvanized sheet (304 quality) with multiple interior designs.**Покрытие** : Оцинкованный лист толщиной 1,5 мм (качество 304)**حوائط الكابينة** : صاج 1.5 مم مجلفن (جودة 304) بتصميمات داخلية متعددة**Tavan** : Lazer tavan. Cam ve led seçeneği mevcuttur.**Ceiling** : Multiple designs designed by laser.**Потолок** : Лазерный потолок. Опционально доступны варианты со стеклом и светодиодами.**السقف** : تصميمات متعددة منقوشة بالليزر**Taban** : 30 mm. Doğal granit**Floor** : 30 mm. Natural granite**Основание** : 30 мм. Основание из натурального гранита**الأرضية** : 30 ملم جرانيت طبيعي**Özellikler / Propertis / Характеристики / المواصفات**

Çalıştırılmaya hazır aydınlatma ve fan.
Kabinlerimizde kayma fren standartı mevcuttur.

Equipped with lighting and ventilation systems.
Special fixing to prevent vibration.

В наших кабинах, оснащенных готовыми к работе освещением и вентилятором, имеются стандартные тормоза скольжения

مجہزہ بأنظمة الانارة و التهوية.
قواعد تثبيت خاصة لمنع الاهتزاز.





Kaplama : 1,5mm galvanizli sac (304 kalite)

Cabin Walls : 1.5 mm galvanized sheet (304 quality) with multiple interior designs.

Покрытие : Оцинкованный лист толщиной 1,5 мм (качество 304)

حوائط الكابينة : صاج 1.5 مم مجلفن (جودة 304) بتصميمات داخلية متعددة

Tavan : Lazer tavan. Cam ve led seçeneği mevcuttur.

Ceiling : Multiple designs designed by laser.

Потолок : Лазерный потолок. Опционально доступны варианты со стеклом и светодиодами.

السقف : تصميمات متعددة منقوشة بالليزر

Taban : 30 mm. Doğal granit

Floor : 30 mm. Natural granite

Основание : 30 мм. Основание из натурального гранита

الأرضية : 30 ملم جرانيت طبيعي

Özellikler / Propertis / Характеристики / المواصفات

Çalıştırılmaya hazır aydınlatma ve fan.
Kabinlerimizde kayma fren standardı mevcuttur.

Equipped with lighting and ventilation systems.
Special fixing to prevent vibration.

В наших кабинах, оснащенных готовыми к работе освещением и вентилятором, имеются стандартные тормоза скольжения

مجھزة بأنظمة الانارة و التهوية.
قواعد تثبيت خاصة لمنع الاهتزاز.



**ÜRÜN KODU
PRODUCT CODE****HD 024**

Kaplama : 1,5mm galvanizli sac (304 kalite)
Cabin Walls : 1.5 mm galvanized sheet (304 quality) with multiple interior designs.
Покрытие : Оцинкованный лист толщиной 1,5 мм (качество 304)
حوائط الكابينة : صاج 1.5 مم مجلفن (جودة 304) بتصميمات داخلية متعددة

Tavan : Lazer tavan. Cam ve led seçeneği mevcuttur.
Ceiling : Multiple designs designed by laser.
Потолок : Лазерный потолок. Опционально доступны варианты со стеклом и светодиодами.
السقف : تصميمات متعددة منقوشة بالليزر

Taban : 30 mm. Doğal granit
Floor : 30 mm. Natural granite
Основание : 30 мм. Основание из натурального гранита
الأرضية : 30 ملم جرانيت طبيعي

Özellikler / Propertis / Характеристики / المواصفات

Çalıştırılmaya hazır aydınlatma ve fan.
Kabinlerimizde kayma fren standartı mevcuttur.

Equipped with lighting and ventilation systems.
Special fixing to prevent vibration.

В наших кабинах, оснащенных готовыми к работе освещением и вентилятором, имеются стандартные тормоза скольжения

مجہزہ بأنظمة الاثارة و التهوية.
قواعد تثبيت خاصة لمنع الاهتزاز.

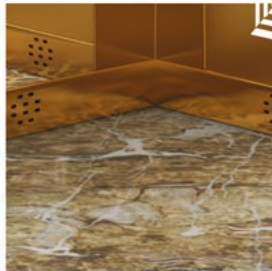
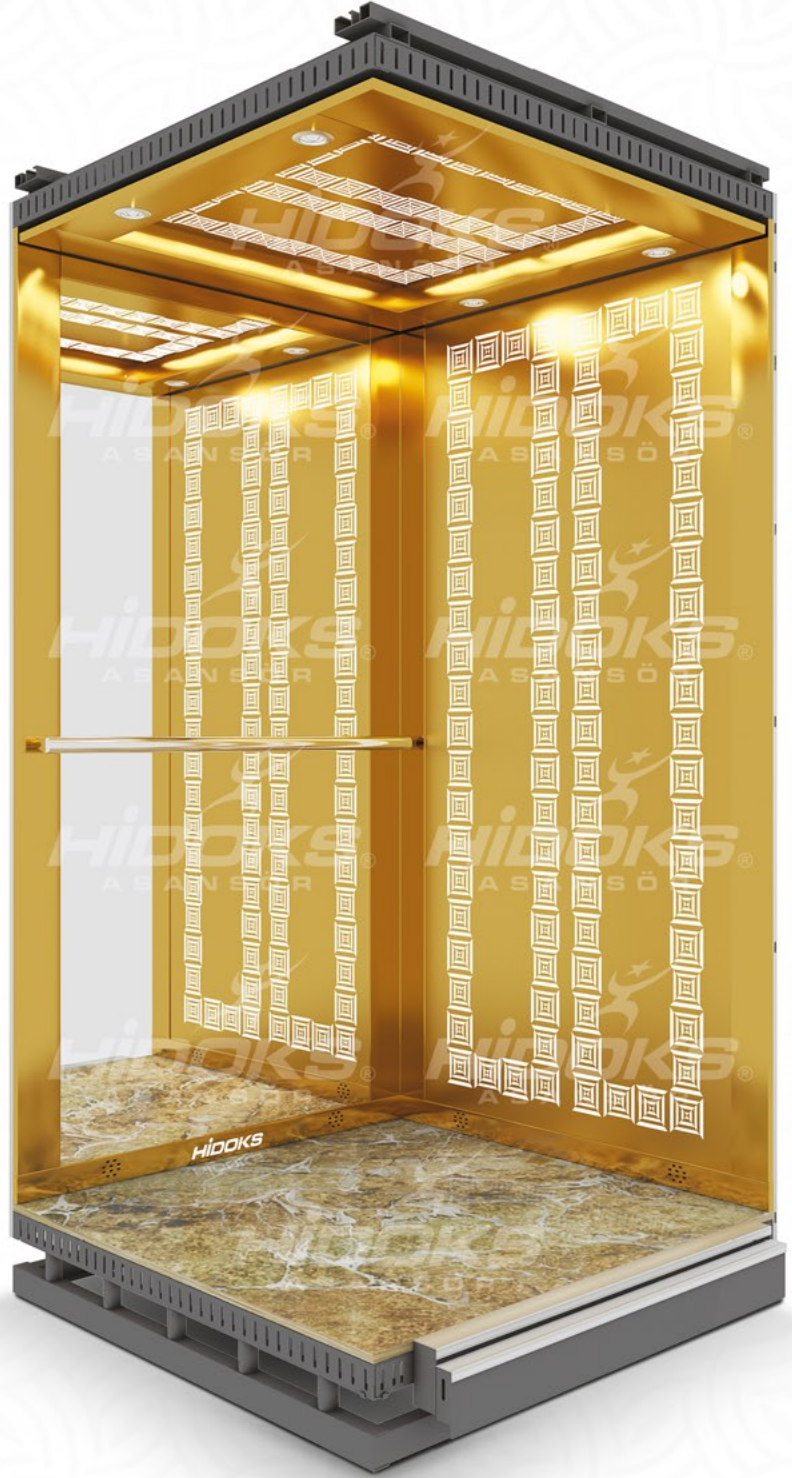



Kaplama : 1,5mm galvanizli sac (304 kalite)

Cabin Walls : 1.5 mm galvanized sheet (304 quality) with multiple interior designs.

Покрытие : Оцинкованный лист толщиной 1,5 мм (качество 304)

حوائط الكابينة : صاج 1.5 مم مجلفن (جودة 304) بتصميمات داخلية متعددة

Tavan : Lazer tavan. Cam ve led seçeneği mevcuttur.

Ceiling : Multiple designs designed by laser.

Потолок : Лазерный потолок. Опционально доступны варианты со стеклом и светодиодами.

السقف : تصميمات متعددة منقوشة بالليزر

Taban : 30 mm. Doğal granit

Floor : 30 mm. Natural granite

Основание : 30 мм. Основание из натурального гранита

الأرضية : 30 ملم جرانيت طبيعي

Özellikler / Propertis / Характеристики / المواصفات

Çalıştırılmaya hazır aydınlatma ve fan.
Kabinlerimizde kayma fren standardı mevcuttur.

Equipped with lighting and ventilation systems.
Special fixing to prevent vibration.

В наших кабинах, оснащенных готовыми к работе освещением и вентилятором, имеются стандартные тормоза скольжения

مجھزة بأنظمة الانارة و التهوية.
قواعد تثبيت خاصة لمنع الاهتزاز.

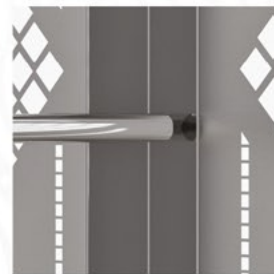
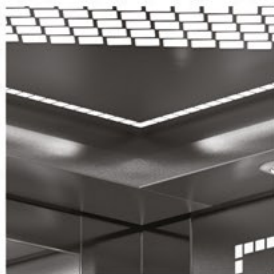

ÜRÜN KODU
PRODUCT CODE**HD 026****Kaplama** : 1,5mm galvanizli sac (304 kalite)**Cabin Walls** : 1.5 mm galvanized sheet (304 quality) with multiple interior designs.**Покрытие** : Оцинкованный лист толщиной 1,5 мм (качество 304)**حوائط الكابينة** : صاج 1.5 مم مجلفن (جودة 304) بتصميمات داخلية متعددة**Tavan** : Lazer tavan. Cam ve led seçeneği mevcuttur.**Ceiling** : Multiple designs designed by laser.**Потолок** : Лазерный потолок. Опционально доступны варианты со стеклом и светодиодами.**السقف** : تصميمات متعددة منقوشة بالليزر**Taban** : 30 mm. Doğal granit**Floor** : 30 mm. Natural granite**Основание** : 30 мм. Основание из натурального гранита**الأرضية** : 30 ملم جرانيت طبيعي**Özellikler / Propertis / Характеристики / المواصفات**

Çalıştırılmaya hazır aydınlatma ve fan.
Kabinlerimizde kayma fren standartı mevcuttur.

Equipped with lighting and ventilation systems.
Special fixing to prevent vibration.

В наших кабинах, оснащенных готовыми к работе освещением и вентилятором, имеются стандартные тормоза скольжения

مجہزہ بأنظمة الانارة و التهوية.
قواعد تثبيت خاصة لمنع الاهتزاز.

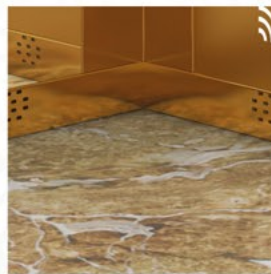
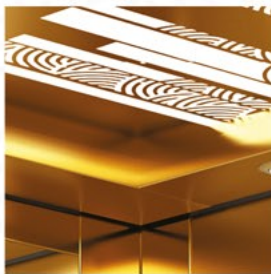
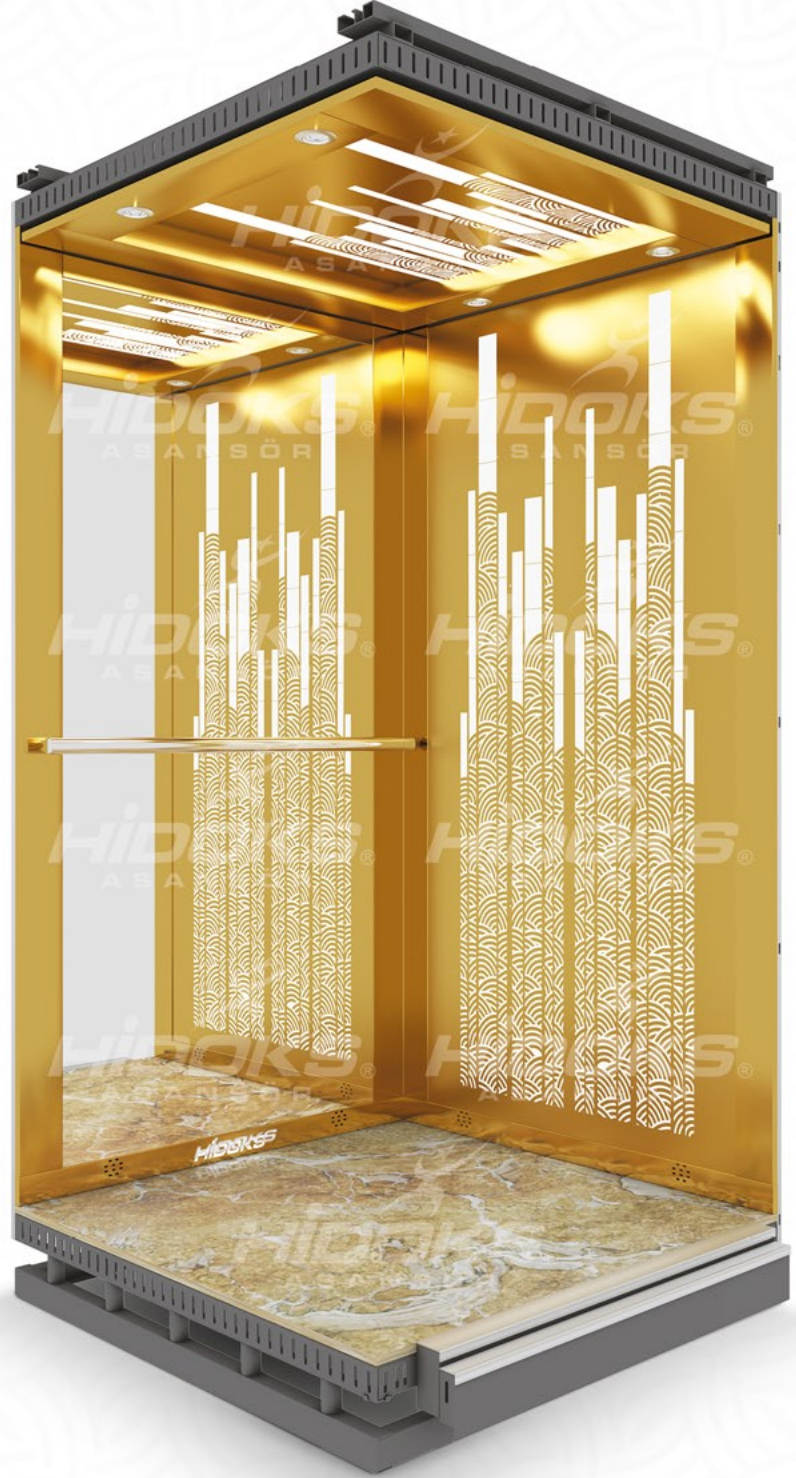



Kaplama : 1,5mm galvanizli sac (304 kalite)

Cabin Walls : 1.5 mm galvanized sheet (304 quality) with multiple interior designs.

Покрытие : Оцинкованный лист толщиной 1,5 мм (качество 304)

حوائط الكابينة : صاج 1.5 مم مجلفن (جودة 304) بتصميمات داخلية متعددة

Tavan : Lazer tavan. Cam ve led seçeneği mevcuttur.

Ceiling : Multiple designs designed by laser.

Потолок : Лазерный потолок. Опционально доступны варианты со стеклом и светодиодами.

السقف : تصميمات متعددة منقوشة بالليزر

Taban : 30 mm. Doğal granit

Floor : 30 mm. Natural granite

Основание : 30 мм. Основание из натурального гранита

الأرضية : 30 ملم جرانيت طبيعي

Özellikler / Propertis / Характеристики / المواصفات

Çalıştırılmaya hazır aydınlatma ve fan.
Kabinlerimizde kayma fren standardı mevcuttur.

Equipped with lighting and ventilation systems.
Special fixing to prevent vibration.

В наших кабинах, оснащенных готовыми к работе освещением и вентилятором, имеются стандартные тормоза скольжения

مجھزة بأنظمة الانارة و التهوية.
قواعد تثبيت خاصة لمنع الاهتزاز.

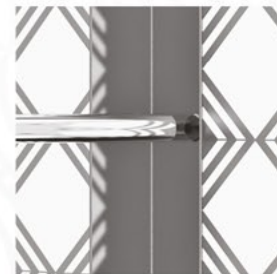
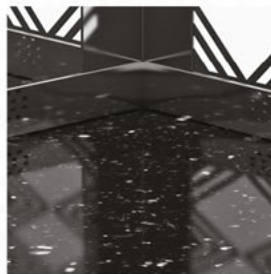

ÜRÜN KODU
PRODUCT CODE**HD 028**

Kaplama : 1,5mm galvanizli sac (304 kalite)
Cabin Walls : 1.5 mm galvanized sheet (304 quality) with multiple interior designs.
Покрытие : Оцинкованный лист толщиной 1,5 мм (качество 304)
حوائط الكابينة : صاج 1.5 مم مجلفن (جودة 304) بتصميمات داخلية متعددة

Tavan : Lazer tavan. Cam ve led seçeneği mevcuttur.
Ceiling : Multiple designs designed by laser.
Потолок : Лазерный потолок. Опционально доступны варианты со стеклом и светодиодами.
السقف : تصميمات متعددة منقوشة بالليزر

Taban : 30 mm. Doğal granit
Floor : 30 mm. Natural granite
Основание : 30 мм. Основание из натурального гранита
الأرضية : 30 ملم جرانيت طبيعي

Özellikler / Propertis / Характеристики / المواصفات

Çalıştırılmaya hazır aydınlatma ve fan.
Kabinlerimizde kayma fren standartı mevcuttur.

Equipped with lighting and ventilation systems.
Special fixing to prevent vibration.

В наших кабинах, оснащенных готовыми к работе освещением и вентилятором, имеются стандартные тормоза скольжения

مجہزہ بأنظمة الاثارة و التهوية.
قواعد تثبيت خاصة لمنع الاهتزاز.

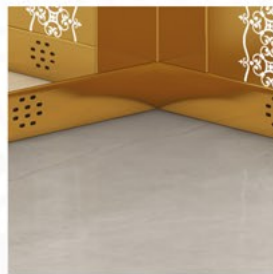
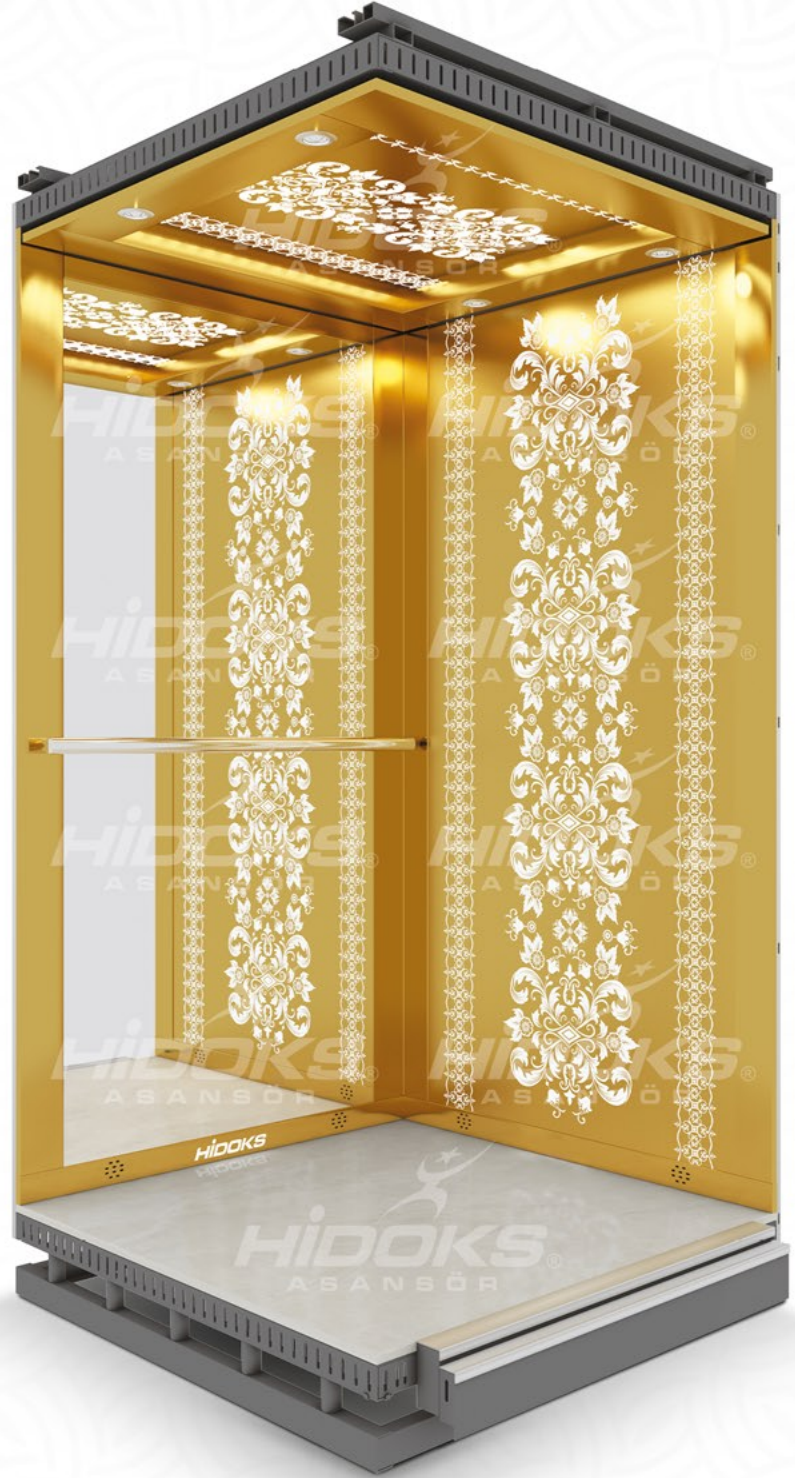



Kaplama : 1,5mm galvanizli sac (304 kalite)

Cabin Walls : 1.5 mm galvanized sheet (304 quality) with multiple interior designs.

Покрытие : Оцинкованный лист толщиной 1,5 мм (качество 304)

حوائط الكابينة : صاج 1.5 مم مجلفن (جودة 304) بتصميمات داخلية متعددة

Tavan : Lazer tavan. Cam ve led seçeneği mevcuttur.

Ceiling : Multiple designs designed by laser.

Потолок : Лазерный потолок. Опционально доступны варианты со стеклом и светодиодами.

السقف : تصميمات متعددة منقوشة بالليزر

Taban : 30 mm. Doğal granit

Floor : 30 mm. Natural granite

Основание : 30 мм. Основание из натурального гранита

الأرضية : 30 ملم جرانيت طبيعي

Özellikler / Propertis / Характеристики / المواصفات

Çalıştırılmaya hazır aydınlatma ve fan.
Kabinlerimizde kayma fren standardı mevcuttur.

Equipped with lighting and ventilation systems.
Special fixing to prevent vibration.

В наших кабинах, оснащенных готовыми к работе освещением и вентилятором, имеются стандартные тормоза скольжения

مجھزة بأنظمة الانارة و التهوية.
قواعد تثبيت خاصة لمنع الاهتزاز.

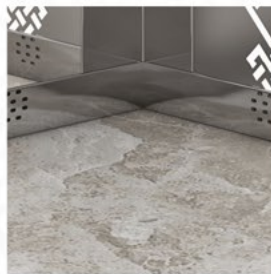
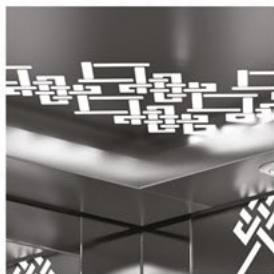

ÜRÜN KODU
PRODUCT CODE**HD 030****Kaplama** : 1,5mm galvanizli sac (304 kalite)**Cabin Walls** : 1.5 mm galvanized sheet (304 quality) with multiple interior designs.**Покрытие** : Оцинкованный лист толщиной 1,5 мм (качество 304)**حوائط الكابينة** : صاج 1.5 مم مجلفن (جودة 304) بتصميمات داخلية متعددة**Tavan** : Lazer tavan. Cam ve led seçeneği mevcuttur.**Ceiling** : Multiple designs designed by laser.**Потолок** : Лазерный потолок. Опционально доступны варианты со стеклом и светодиодами.**السقف** : تصميمات متعددة منقوشة بالليزر**Taban** : 30 mm. Doğal granit**Floor** : 30 mm. Natural granite**Основание** : 30 мм. Основание из натурального гранита**الأرضية** : 30 ملم جرانيت طبيعي**Özellikler / Propertis / Характеристики / المواصفات**

Çalıştırılmaya hazır aydınlatma ve fan.
Kabinlerimizde kayma fren standartı mevcuttur.

Equipped with lighting and ventilation systems.
Special fixing to prevent vibration.

В наших кабинах, оснащенных готовыми к работе освещением и вентилятором, имеются стандартные тормоза скольжения

مجّهة بأنظمة الانارة و التهوية.
قواعد تثبيت خاصة لمنع الاهتزاز.





Kaplama : Cam görsel uygulaması

Cabin Walls : Glass visual application

Покрытие : применение визуального стекла

حوائط الكابينة : تطبيق بصري زجاجي

Tavan : Lazer tavan. Cam ve led seçeneği mevcuttur.

Ceiling : Multiple designs designed by laser.

Потолок : Лазерный потолок. Опционально доступны варианты со стеклом и светодиодами.

السقف : تصميمات متعددة منقوشة بالليزر

Taban : 30 mm. Doğal granit

Floor : 30 mm. Natural granite

Основание : 30 мм. Основание из натурального гранита

الأرضية : 30 ملم جرانيت طبيعي

Özellikler / Propertis / Характеристики / المواصفات

Çalıştırılmaya hazır aydınlatma ve fan.

Kabinlerimizde kayma fren standardı mevcuttur.

Equipped with lighting and ventilation systems.

Special fixing to prevent vibration.

В наших кабинах, оснащенных готовыми к работе освещением и вентилятором, имеются стандартные тормоза скольжения

مجھزة بأنظمة الانارة و التهوية.
قواعد تثبيت خاصة لمنع الاهتزاز.

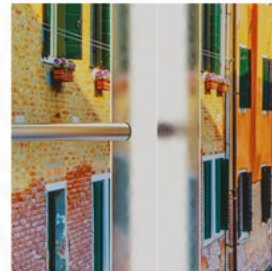
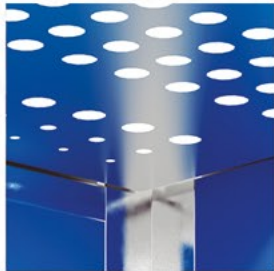

**ÜRÜN KODU
PRODUCT CODE****HD 032**

Kaplama : Cam görsel uygulaması
Cabin Walls : Glass visual application
Покрытие : применение визуального стекла
حوائط الكابينة : تطبيق بصري زجاجي

Tavan : Lazer tavan. Cam ve led seçeneği mevcuttur.
Ceiling : Multiple designs designed by laser .
Потолок : Лазерный потолок. Опционально доступны варианты со стеклом и светодиодами.
السقف : تصميمات متعددة منقوشة بالليزر

Taban : 30 mm. Doğal granit
Floor : 30 mm. Natural granite
Основание : 30 мм. Основание из натурального гранита
الأرضية : 30 ملم جرانيت طبيعي

Özellikler / Propertis / Характеристики / المواصفات

Çalıştırılmaya hazır aydınlatma ve fan.
Kabinlerimizde kayma fren standartı mevcuttur.

Equipped with lighting and ventilation systems.
Special fixing to prevent vibration.

В наших кабинах, оснащенных готовыми к работе освещением и вентилятором, имеются стандартные тормоза скольжения

مجھزة بأنظمة الاثارة و التهوية.
قواعد تثبيت خاصة لمنع الاهتزاز.

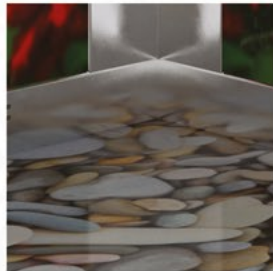



C 100



C 101



C 102



C 103



C 104



C 105



C 106



C 107



C 108



C 109



C 110



C 111



C 112



C 113



C 114



Kaplama : 1,5mm galvanizli sac (304 kalite)

Cabin Walls : 1.5 mm galvanized sheet (304 quality)
with multiple interior designs.

Покрытие : Оцинкованный лист толщиной 1,5 мм
(качество 304)

حوائط الكابينة : صاج 1.5 مم مجلفن (جودة 304) بتصميمات
داخلية متعددة

Tavan : Lazer tavan. Cam ve led seçeneği mevcuttur.

Ceiling : Multiple designs designed by laser .

Потолок : Лазерный потолок. Опционально доступны
варианты со стеклом и светодиодами.

السقف : تصميمات متعددة منقوشة بالليزر

Taban : 30 mm. Doğal granit

Floor : 30 mm. Natural granite

Основание : 30 мм. Основание из натурального
гранита

الأرضية : 30 ملم جرانيت طبيعي

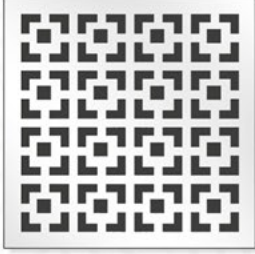

HT 01

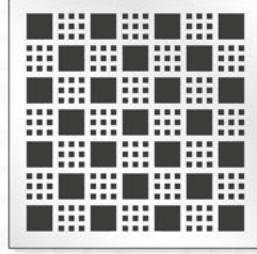

HT 02



HT 03



HT 04



HT 05



HT 06



HT 07



HT 08

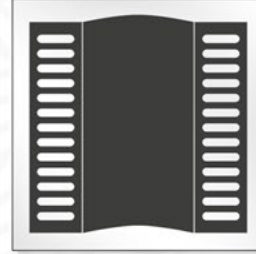

HT 09

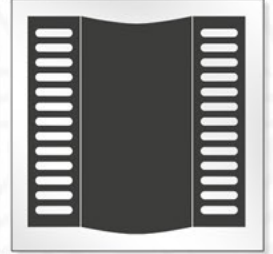

HT 10

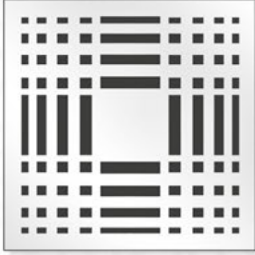

HT 11

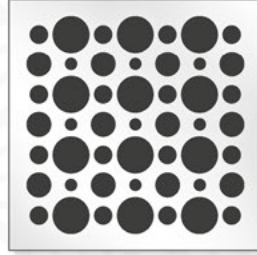

HT 12



HT 13



HT 14



HT 15



HT 16



HT 17

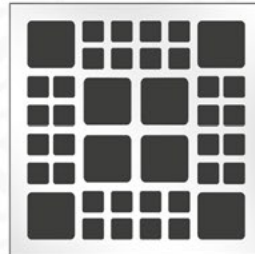

HT 18



HT 19



HT 20

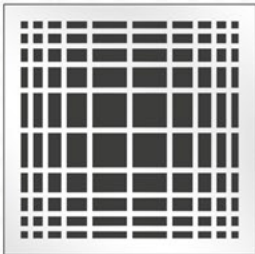

HT 21



HT 22



HT 23



HT 24



HT 25



P 001



P 002

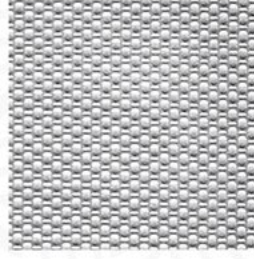

P 003

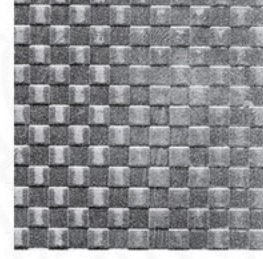

P 004



P 005



P 006

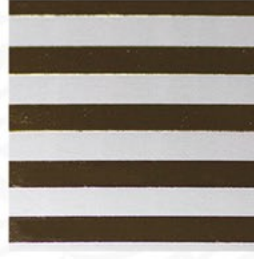

P 007



P 008



P 009



P 010



P 011



P 012



P 013

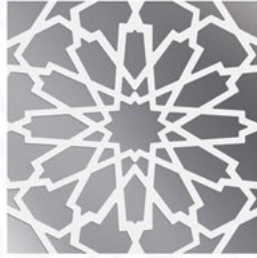

P 014



P 015



P 016



P 017



P 018



P 019

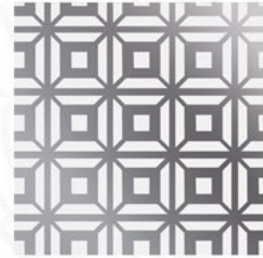

P 020



P 021



P 022



P 023



P 024



Z 101



Z 102



Z 103



Z 104



Z 105



Z 106



Z 107



Z 108



Z 109

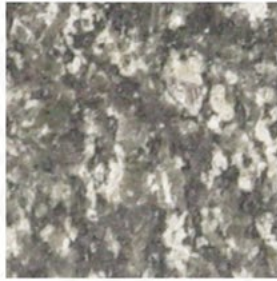

Z 110



Z 111



Z 112

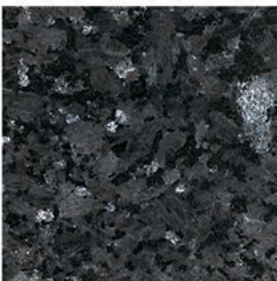

Z 113

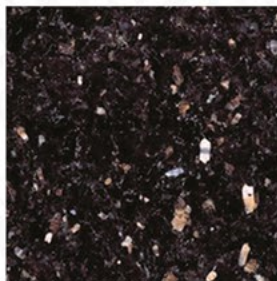

Z 114



Z 115



Z 116



Z 117

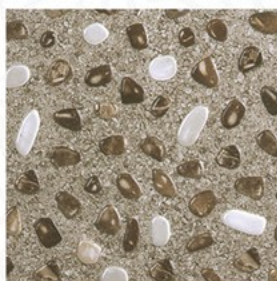

Z 118



Z 119

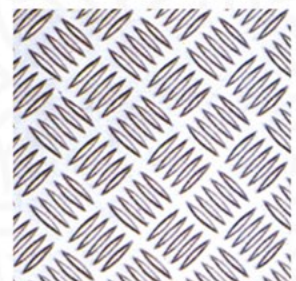

Z 120

HIDOKS®

ASANSÖR

PANOLAR

CONTROL PANELS / СИСТЕМА УПРАВЛЕНИЯ

الكونتروليات

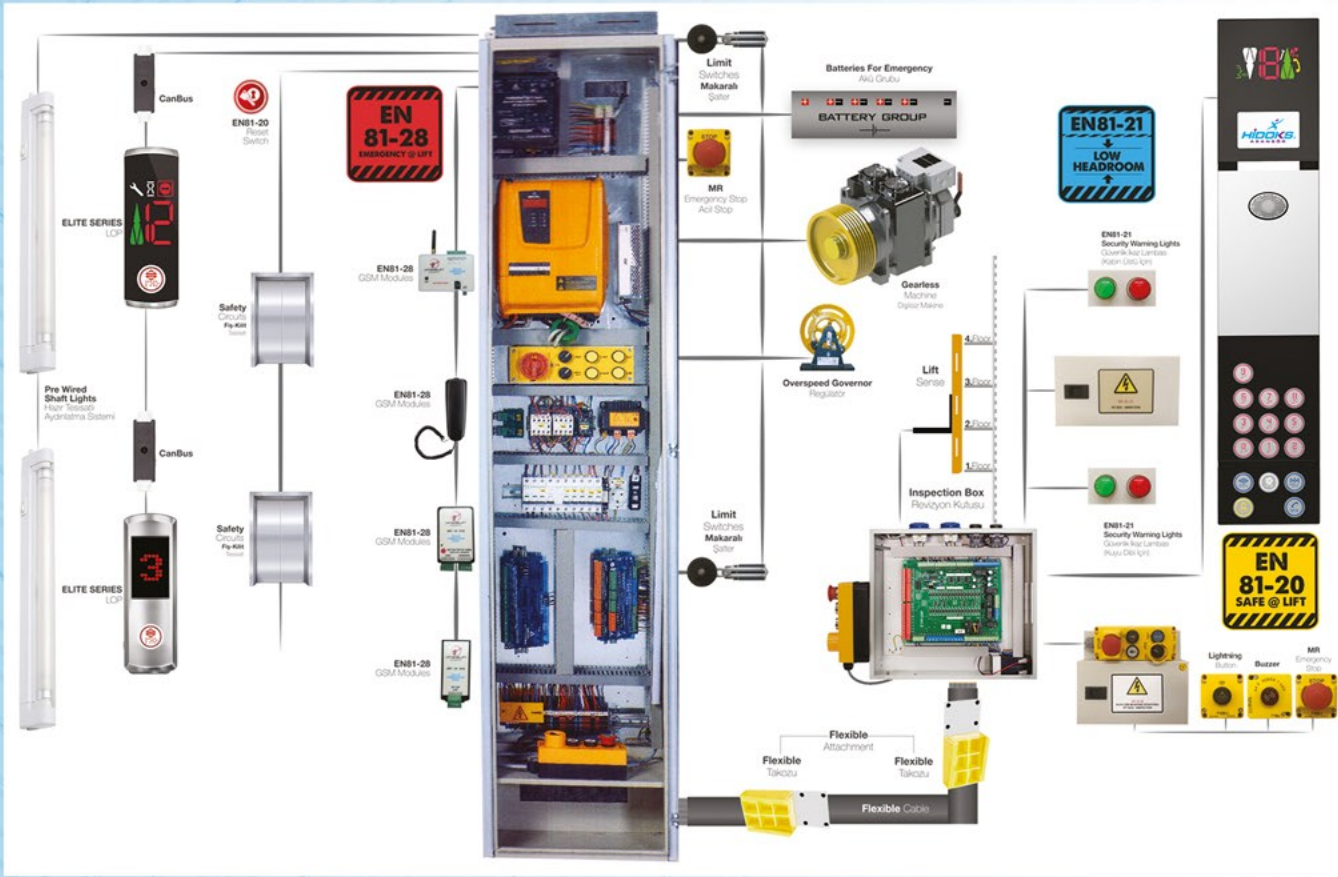

HEDEFSAN
ASANSÖR KONTROL SİSTEMLERİ

MEIDEN

mikrolift

ARKEL

SIEMENS

Schneider
Electric

Monarch
Elevator Control Expert Step With the World

YASKAWA

STEP

FUJITEC

Seri Bağlantılı Revizyon Kutusu
Revision Box With Serial Connection
Ревизионная коробка для серийных соединений
صندوق الصيانة مع لوحة الاتصال التسلسلي

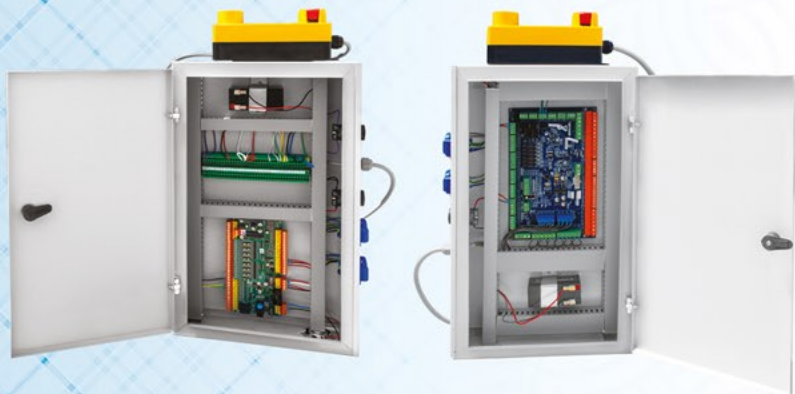



MRL (Dişlisiz) Sistemler İçin Kontrol Cihazı Makine Dairesiz - Ral 7032 / Paslanmaz Çelik
Control Panel For Gearless - Machine Roomless System (MRL) - Ral 7032 / Stainless Steel
Машинное отделение устройства управления для систем MRL (безредукторных)
Ral 7032/ Нержавеющая сталь

وحدة التحكم الخاصة بالمصاعد الغير مزودة بغرفة للمحرك (روملس)



Dişlisiz, Dişlili - Makine Dairesi Sistemi (MR) Kontrol Paneli

Control Panel For Gearless, Geared - Machine Room System (MR)

Панель управления для безредукторного редуктора - система машинного отделения (MR)

وحدة التحكم الخاصة بالمصاعد المزودة بغرفة للمحرك



ÇARPMA KAPILAR
MANUAL DOORS
ПОЛУАВТОМАТИЧЕСКИЕ ДВЕРИ
أبواب نصف أوتوماتيكية



ÇARPMA KAPILAR
MANUAL DOORS
ПОЛУАВТОМАТИЧЕСКИЕ ДВЕРИ
أبواب نصف أوتوماتيكية

HIDOKS
ASANSÖR®



HM01



HM02



HM03



HM04



HM05



HM06



ОТОМАТИК КАРІЛАР
AUTOMATIC DOORS
АВТОМАТИЧЕСКИЕ ДВЕРИ
أبواب أوتوماتيكية





2 PANEL SAĞ TELESKOPİK
2 PANEL TELESCOPIC RIGHT
2 ПАНЕЛЬ СПРАВА
جانبي يمين ضلف عدد 2



2 PANEL SOL TELESKOPİK
2 PANEL TELESCOPIC LEFT
2 ПАНЕЛИ СЛЕВА
جانبي يسار ضلف عدد 2



3 PANEL SAĞ TELESKOPİK
3 PANEL TELESCOPIC RIGHT
3 ПАНЕЛЬ СПРАВА
جانبي يمين ضلف عدد 3



3 PANEL SOL TELESKOPİK
3 PANEL TELESCOPIC LEFT
3 ПАНЕЛИ СЛЕВА
جانبي يسار ضلف عدد 3



2 PANEL MERKEZİ

2 PANEL CENTRAL

МЕХАНИЗМ ДВЕРИ КАБИНЫ ДВЕРЕЙ
ЦЕНТРАЛЬНОГО ОТКРЫВАНИЯ

مرکزي ضلف عدد 2



4 PANEL MERKEZİ

4 PANEL CENTRAL

МЕХАНИЗМ ДВЕРИ КАБИНЫ ДВЕРЕЙ
ЦЕНТРАЛЬНОГО ОТКРЫВАНИЯ

مرکزي ضلف عدد 4

6 PANEL MERKEZİ
6 PANEL CENTRAL
МЕХАНИЗМ ДВЕРИ КАБИНЫ ДВЕРЕЙ
ЦЕНТРАЛЬНОГО ОТКРЫВАНИЯ

مرکزي ضلف عدد 6



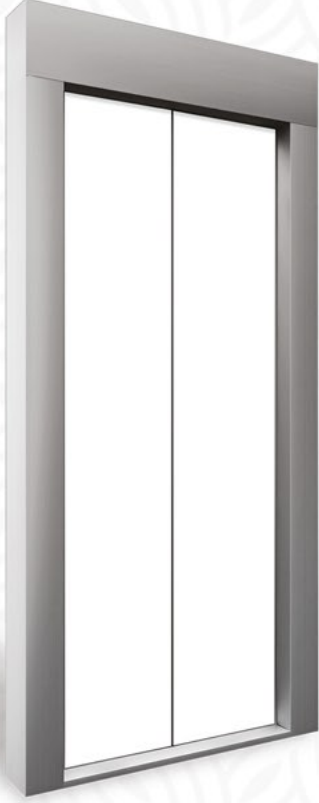

KOMPLE CAM PANELİ
FRAMLESS GLASS PANEL
ПОЛНАЯ СТЕКЛЯННАЯ ПАНЕЛЬ
ضلف زجاجية كاملة



ÇERÇEVELİ CAM PANELİ
FRAMED GLASS PANEL
PAMKA İZ STEKLA
ضلف زجاجية مع اطارات



HK01



HK02



HK03



HK04



HK05



HK06



HK07



HK08

ОТОМАТИК КАПИЛАР
AUTOMATIC DOORS
АВТОМАТИЧЕСКИЕ ДВЕРИ
أبواب نصف أوتوماتيكية

HIDOKS
ASANSÖR®



HK09



HK10



HK11



HK12



HK13



HK14

4 PANEL MERKEZİ KABİN MEKANİZMASI

CABIN MECHANISM - 4 PANELS

МЕХАНИЗМ ДВЕРИ ШАХТЫ ДВЕРЕЙ ЦЕНТРАЛЬНОГО ОТКРЫВАНИЯ

باب الكابین - 4 ضلف



4 PANEL MERKEZİ KAT MEKANİZMASI

LANDING MECHANISM - 4 PANELS

МЕХАНИЗМ ДВЕРИ КАБИНЫ ДВЕРЕЙ ЦЕНТРАЛЬНОГО ОТКРЫВАНИЯ

باب الطابق - 4 ضلف



2 PANEL MERKEZİ KABİN MEKANİZMASI

CABIN MECHANISM - 2 PANELS

МЕХАНИЗМ ДВЕРИ ШАХТЫ ДВЕРЕЙ ЦЕНТРАЛЬНОГО ОТКРЫВАНИЯ

باب الكابین - 2 ضلف

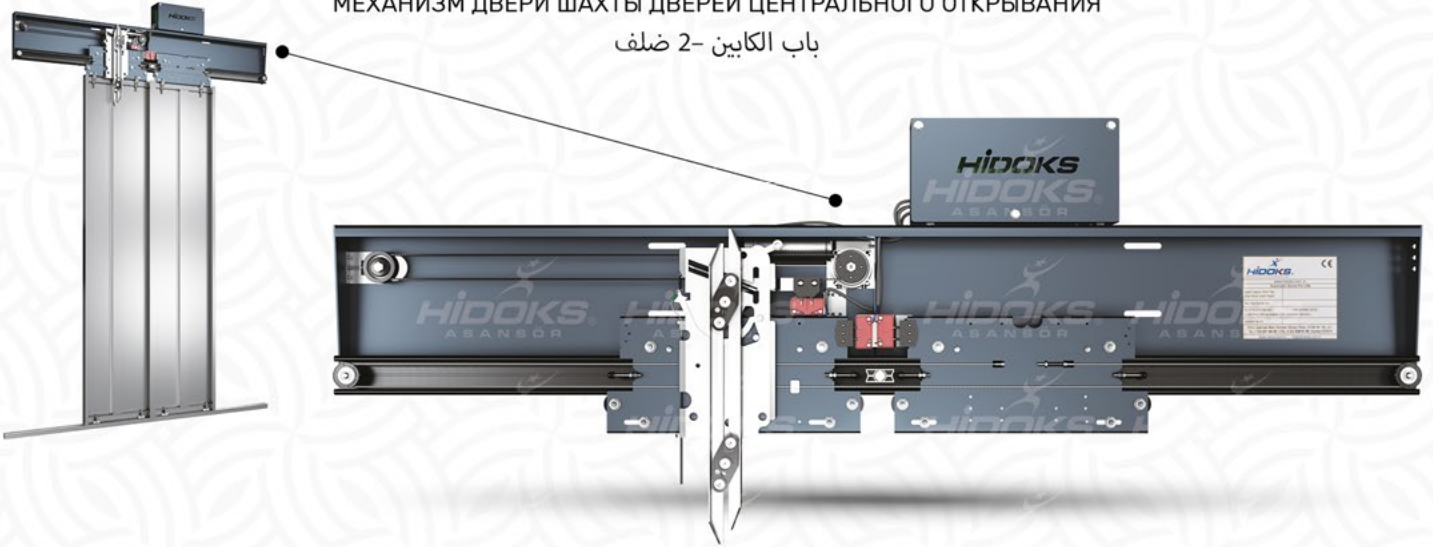

2 PANEL MERKEZİ KAT MEKANİZMASI

LANDING MECHANISM - 2 PANELS

МЕХАНИЗМ ДВЕРИ КАБИНЫ ДВЕРЕЙ ЦЕНТРАЛЬНОГО ОТКРЫВАНИЯ

باب الطابق - 2 ضلف



3 PANEL TELESKOPIK KABİN PANELİ

CABIN MECHANISM - 3 PANELS

АВТОМАТИЧЕСКИЙ МЕХАНИЗМ ОТКРЫВАЮЩАЯСЯ ДВЕРЬ (ТЕЛЕСКОПИЧЕСКА)

باب الكابین - 3 ضلف



3 PANEL TELESKOPIK KAT PANELİ

LANDING MECHANISM - 3 PANELS

МЕХАНИЗМ АВТОМАТИЧЕСКОГО ОТКРЫВАНИЯ ДВЕРЕЙ (ТЕЛЕСКОПИЧЕСКА)

باب الطابق - 3 ضلف



2 PANEL TELESKOPIK KABİN PANELİ

CABIN MECHANISM - 2 PANELS

АВТОМАТИЧЕСКИЙ МЕХАНИЗМ ОТКРЫВАЮЩАЯСЯ ДВЕРЬ (ТЕЛЕСКОПИЧЕСКА)

باب الكابین - 2 ضلف

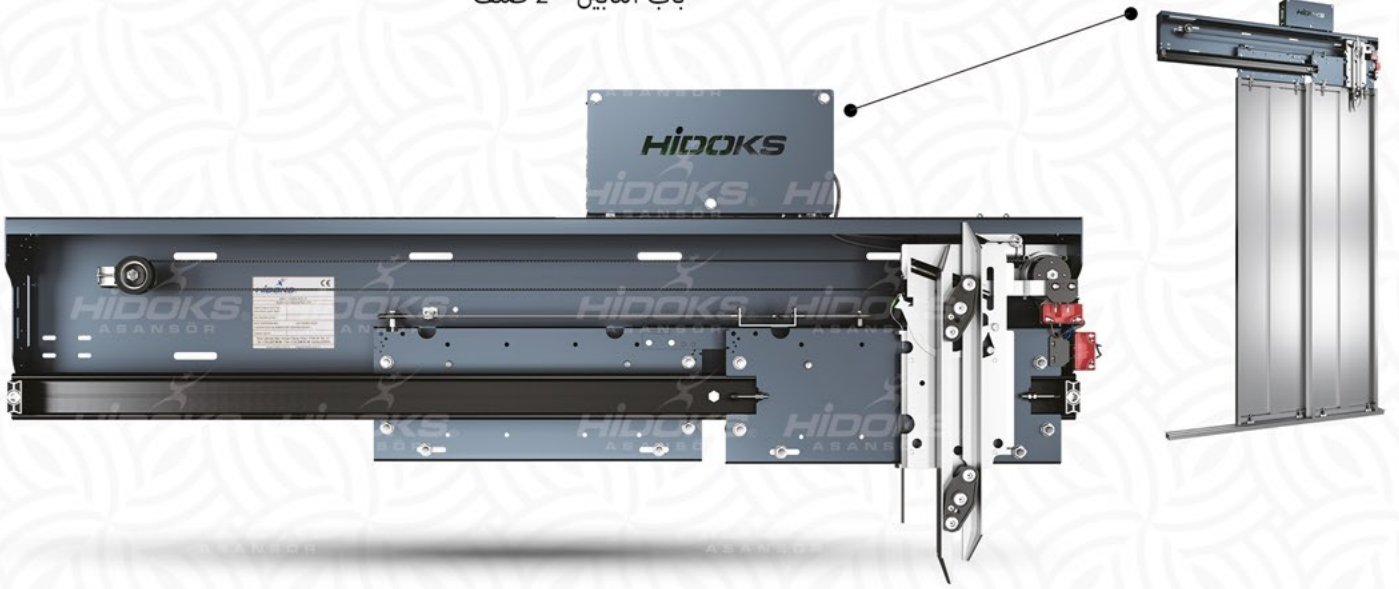

2 PANEL TELESKOPIK KAT PANELİ

LANDING MECHANISM - 2 PANELS

МЕХАНИЗМ АВТОМАТИЧЕСКОГО ОТКРЫВАНИЯ ДВЕРЕЙ (ТЕЛЕСКОПИЧЕСКА)

باب الطابق - 2 ضلف





MAKİNE MOTORLAR
TRACTION MACHINES
ЛЕБЕДКИ
المحركات

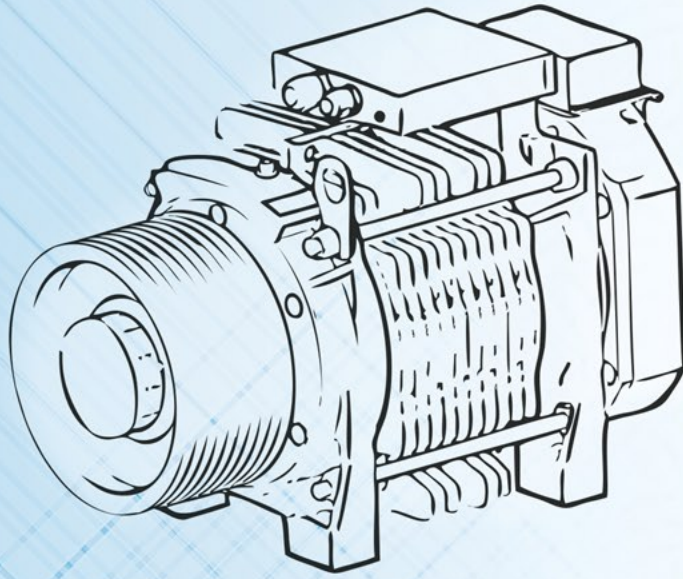

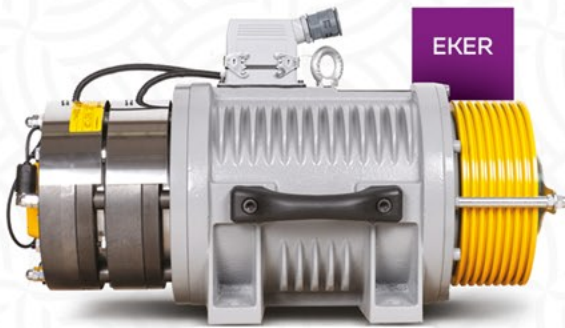

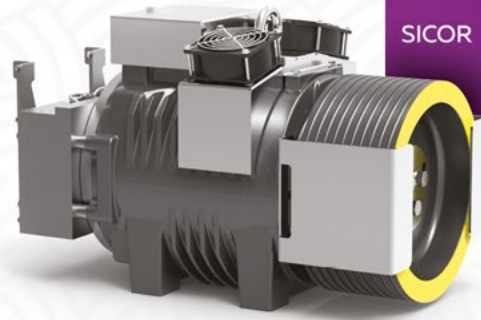



EV ASANSÖRÜ
HOMELIFT
ДОМ ПОДЪЕМНИК

مصاعد منزلية (هوم ليفت)

Teknolojinin
yükselişi



www.hidoks.com.tr





İç ve dış mekan merdivenlere monte edilir. Yürüme engelli veya tekerlekli sandalye kullanıcılarının refakatçıya ihtiyaç duymadan güvenli bir şekilde ulaşımını sağlar. Merdiven kenarında duvara veya basamaklara özel ayakları ile monte edilen özel raylar üzerinde hareket eder. Dış ortam şartlarına uygun, dış kaplaması paslanmaz malzemeden imal edilmektedir. Kullanılmadığı zamanlar otomatik olarak katlanır ve yer işgal etmez. Kullanım alanları; Okul, camii, karakol, rehabilitasyon merkezleri, kamu kurumları, otel, sağlık kuruluşları, eğitim merkezleri, site alanları vb. yerlerde tercih edilir.

This model is suitable on indoor and outdoor stairs. It provides safe access for disabled or wheelchair users without the need for a companion. It moves on special rails mounted on the wall or steps with special feet on the stair edge. Exterior coating is made of stainless steel. When not in use, it folds automatically and does not occupy space. Area of usage; School, temples, police station, rehabilitation center, public institutions, hotels, health facilities, training centers, housing estates.



DİKEY TİP ENGELLİ PLATFORMU
VERTICAL TYPE DISABLED PLATFORM
ПЛАТФОРМА ДЛЯ ИНВАЛИДОВ ВЕРТИКАЛЬНОГО ТИПА
مصعد خارجي خاص بذوي الاحتياجات الخاصة



Düşük maliyetli olması ve az yer kaplaması ürünün tercih sebeplerini arttırır. İç ve dış mekanda güvenle kullanılır. Dış kaplaması paslanmaz malzemeden oluşmaktadır. Kuyu gerektirmez ve 3 metrelik kod farklarına kadar seyir mesafesi vardır. Kullanım alanları, okul, camii, karakol, rehabilitasyon merkezleri, kamu kurumları, otel, sağlık kuruluşları, eğitim merkezleri, site alanları vb. yerlerde tercih edilir.

This model has low cost and occupies smaller place than other types. It can be used safely indoor and outdoor. The outer cover is made of stainless steel. It does not require pit and travels from ground up to 3 meters. Area of usage; School, temples, police station, rehabilitation center, public institutions, hotels, health facilities, training centers, housing estates.





Kapalı tip engelli platformu, sonsuz vidalı sistem olarak üretilmektedir. Aşırı soğuk iklim koşulları için tasarlanmış bir üründür. Kullanım alanları; okul, hastane, camii, karakol, konut, kamu kurumları, alt ve üst geçitler, rehabilitasyon merkezleri, sürücü kursları vb. kamu ve özel alanlarda yaygın olarak kullanıma uygundur.

Close type vertical transport platform, produce endless screw systems. Designed for extreme cold climatic conditions. Use place; school, hospital, mosques, outposts, public institutions, pedestrian passages and bridges, rehabilitation centers, driving courses and so on. It is widely used in public and private area.



MAKASLI YÜK PLATFORMU
SCISSOR TYPE LOAD DISABLED PLATFORM
НОЖНИЧНЫЙ ГРУЗОВОЙ ПОДЪЕМНИК
منصة تحميل آلية حركة المقص



10.000-100 kg kaldırma kapasitesine ve istenilen tabla ölçüsüne göre platform yapılır. İstenilen platform ebadına ve kaldırma yüksekliğine göre tek ve çok makaslı sistemler kullanılır. Sessiz hidrolik aksamlar kullanılır. Sürtünen yüzeyler makaralı rulman kullanımı sayesinde uzun ömürlüdür. Kuyu içine yerleştirilen platformlar kullanılmadığı zamanlar yer işgal etmez, maksimum alan kullanımı sağlar. Kullanım alanları; araç asansörleri, depolar, alışveriş merkezleri, fabrikalar kısacası kat ve kot farkı bulunan yerlerde tercih edilir.

The Load Capability will be 10.000-100 kg, the platform is made according to required table size. Single and multi-scissor systems are used for the required platform size. It uses silent hydraulic components it use the roller bearings will be. The frictional surfaces are longevity. Do not need a pit to work. Usage areas; car lifts, warehouses, shopping malls, factories.





Makine Daireli Sistemler

Machine Room Systems (MR)

Системы с машинным отделением

مصاعد بغرفة للمحرك

Biz HİDOKS ASANSÖR ekibi olarak; üretimin hızını, kalitesini, güvenilirliğini ve teknolojik alt yapısını geliştirmek adına yatırımlara hız kesmeden devam etmekteyiz. Sürekli aynı üretimi yapmak yerine yenilikçi düşünerek daha modern ürünler ve kaliteli hizmet anlayışını benimsiyoruz.

Profesyonel montaj ekibimiz her türlü asansörün montaj ve hizmetini sunmaktadır. Asansör sektöründe yüzdeyüz müşteri memnuniyeti ile global standartlar çerçevesinde ürün ve hizmet sunan firmamız, konusunda Uzman ve deneyimli ekipler çalıştırarak etkin bir yapılaşma sağlamıştır.

Makine Dairesiz Sistemler

Machine Roomless Systems

Системы без машинного отделения

مصاعد بدون غرفة للمحرك (روملس)

We as the HIDOKS ELEVATOR team; in order to improve the speed, quality, reliability and technological infrastructure of production, we continue to invest without slowing down. Instead of producing the same continuously, we adopt more modern products and quality service by thinking innovatively.

Our professional assembly team offers the installation and service of all kinds of elevators. Our company, which provides products and services within the framework of global standards with customer satisfaction of 100 percent in the elevator sector, has provided an effective construction by employing expert and experienced teams in its field.

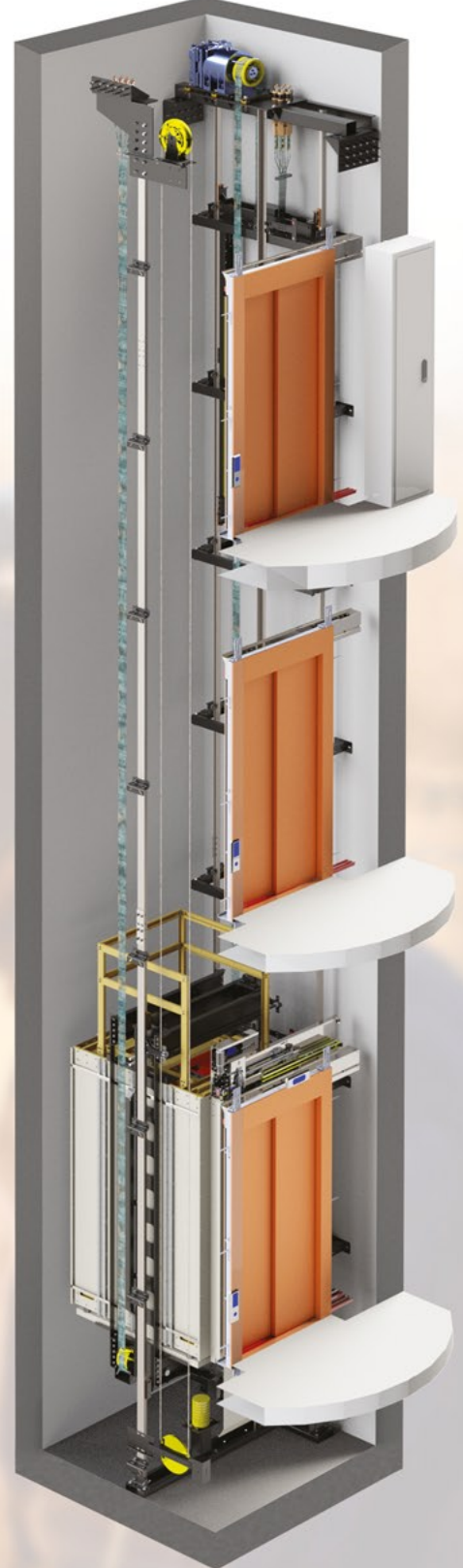

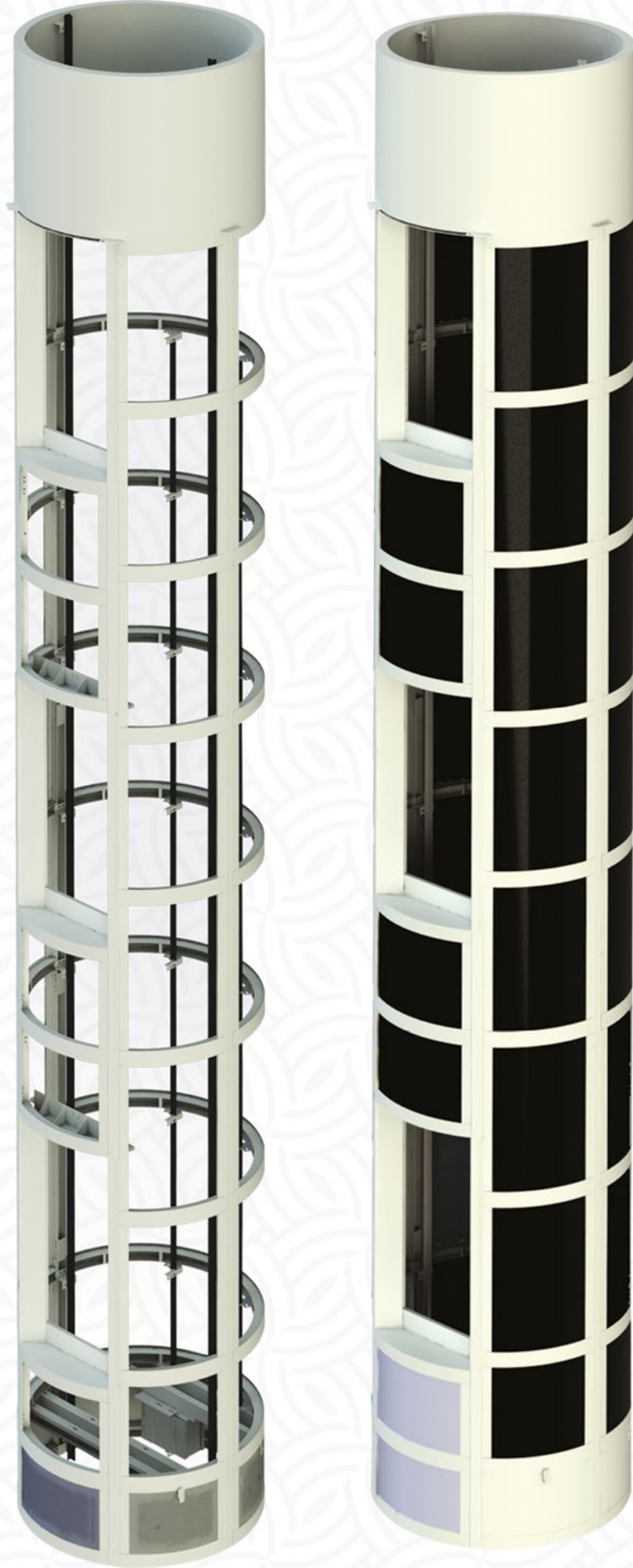

ÇELİK YAPI SİSTEMLERİ
ELEVATOR STEEL CONSTRUCTION
СИСТЕМЫ СТАЛЬНЫХ
КОНСТРУКЦИЙ.

مصاعد مزودة ببرج معدني (دائري أو مربع)



DIŞLİSİZ MAKİNE ŞASESİ (1:1)
MACHINE ROOMLESS SYSTEM (MRL)
БЕЗ МАШИННОГО ПОМЕЩЕНИЯ
تعليق بدون غرفة للمحرك (روملس)



DIŞLİSİZ MAKİNE ŞASESİ (2:1)
MACHINE ROOMLESS SYSTEM (MRL)
БЕЗ МАШИННОГО ПОМЕЩЕНИЯ
تعليق بدون غرفة للمحرك (روملس)



DIŞLİSİZ MAKİNE ŞASESİ
GEARLESS MACHINE BED FRAME
БЕЗ МАШИННОГО ПОМЕЩЕНИЯ
قاعدة محرك بعلبة تروس



DIŞLİLİ MAKİNE ŞASESİ
GEARED MACHINE BED FRAME
С МАШИНЫМ ПОМЕЩЕНИЕМ
قاعدة محرك بغرفة محرك

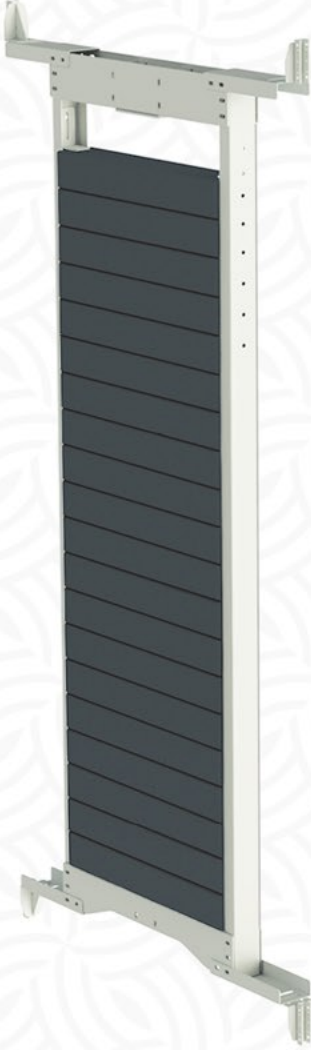

AĞIRLIK ŞASESİ
COUNTER WEIGHT SUSPENSION
КАРКАС ПРОТИВОВЕСА
ПАССАЖИРСКОГО ЛИФТА
(الموازن (الثقال)



AĞIRLIK ŞASESİ
COUNTER WEIGHT SUSPENSION
КАРКАС ПРОТИВОВЕСА
ПАССАЖИРСКОГО ЛИФТА
(الموازن (الثقال)



AĞIRLIK ŞASESİ
COUNTER WEIGHT SUSPENSION
КАРКАС ПРОТИВОВЕСА
ПАССАЖИРСКОГО ЛИФТА
(الموازن (الثقال)



TAMPON
PLASTIC BUFFER
БУФЕР
مخمد مطاطس



HİDROLİK TAMPON
HYDRAULIC BUFFER
ГИДРАВЛИЧЕСКИЙ БУФЕР
مخمد هيدروليكي



L KARKAS
TRACTION L-FRAME SUSPENSION
РАМА КАБИНЫ РЮКЗАЧНОГО
ТИПА
تعليق مصعد كهربائي

HİDROLİK KARKAS
HYDRAULIC L-FRAME SUSPENSION
ГИДРАВЛИЧЕСКАЯ РАМА
تعليق نظام هيدروليك



KABİN SÜSPANSİYON 2:1
2:1 L-FRAME SUSPENSION
КАРКАС КАБИНА
(ШКИВ 2:1 В ОБОИХ СЛУЧАЯХ.)
تعليق مصعد كهربائي

KABİN SÜSPANSİYON 2:1
2:1 L-FRAME SUSPENSION
КАРКАС КАБИНА (ШКИВ 2:1 В ОБОИХ СЛУЧАЯХ.)
تعليق مصعد كهربائي



BUTONLAR
OPERATING PANELS
ПЕРИФЕРИЙНАЯ АППАРАТУРА
لوحات الطلب



BUTONLAR
OPERATING PANELS
ПЕРИФЕРИЙНАЯ АППАРАТУРА
لوحات الطلب



HB01



HB02



HB03



HB04



HB05

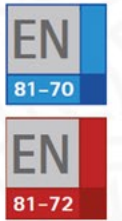

HB06



HB07



HB08



HB09



HB10



HB11

HB12

HB13

HB14

HB15

HB16

HB17



HB35



HB18



HB19



HB20



HB21



HB22



HB36



HB23



HB24



HB25



HB26



HB27



HB28



HB37



HB38



HB39



HB29



HB30



HB31



HB32



HB33



HB34

BUTONLAR
OPERATING PANELS
ПЕРИФЕРИЙНАЯ АППАРАТУРА
لوحات الطلب

EN
81-70
EN
81-72



HB40



HB41



HB42



HB43



HB44



HB46



HB47



HB48



HB45



HB49



HB50



HB51



HB29



HB30



HB31



HB32



HB33



HB34



HB35



HB36



HB37



HB38



HB39



HB40



HB41

ACİL ARAMA KURTARMA SİSTEMİ
URGENT SEARCH AND RESCUE SYSTEM
نظام بحث وإنقاذ عاجل



PANOYA KONULAN
ANA KONTROL CİHAZI
ON THE PANEL
MAIN CONTROLLER
وحدة التحكم الرئيسية موضوعة على اللوحة



KABİN ÜSTÜ
CABIN TOP
أعلى المقصورة
KONUŞMA
MODÜLÜ
Talk
Module
وحدة الكلام

KABİN
CABIN
المطابق
KONUŞMA
MODÜLÜ
Talk
Module
وحدة الكلام

KABİN
CABIN
المطابق
KONUŞMA
MODÜLÜ
Talk
Module
وحدة الكلام

KABİN
CABIN
المطابق
KONUŞMA
MODÜLÜ
Talk
Module
وحدة الكلام

KUYUDİBİ
WELL
حسنا
KONUŞMA
MODÜLÜ
Talk
Module
وحدة الكلام

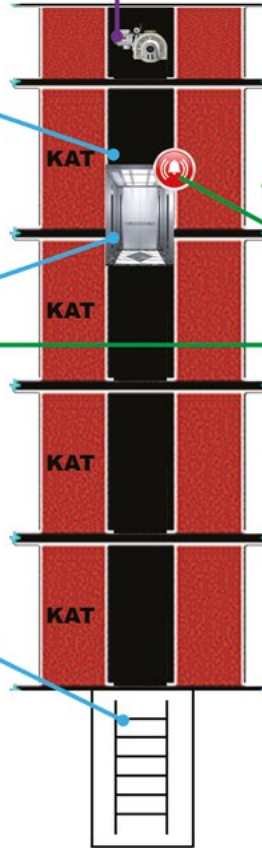

Alarm butonuna belli süreli basıldığında belirlenen numarayı aramaya başlayacaktır.

Alarm button pressed for a certain amount of time designated number will start searching.

زر التنبيه
الضغط لفترة معينة من الوقت
الرقم المعين
سيبدأ البحث.

EN
81-70

İnsan Asansörleri (Sınıf I - II) Fonksiyonel Boyutlar

			KONUTLAR				İŞYERLERİ						
TAŞIMA KAPASİTESİ			(Kg)	320	400	630	1000	630	800	1000	1250	1600	
ANMA YÜKÜ			(Kişi)	4	5	8	13	8	10	13	16	21	
KABİN ALANI			(min)	0,79	0,98	1,45	2,15	1,45	1,73	2,15	2,57	3,245	
			(max)	0,95	1,17	1,66	2,4	1,66	2	2,4	2,9	3,56	
KABİN EBATLARI	Genişlik	b1	(mm)	900	1100	1100	1100	1100	1350	1600	1950	1950	
	Derinlik	d1	(mm)	1000	1000	1400	2100	1400	1400	1400	1400	1750	
	Yükseklik		(mm)	2200	2200	2200	2200	2200	2200	2300	2300	2300	
DURAK KAPILARI	Genişlik	b2	(mm)	700	800	800	800	800	800	1100	1100	1100	
	Yükseklik	h3	(mm)	2000	2000	2000	2000	2000	2000	2100	2100	2100	
KUYU EBATLARI	Genişlik *	b3	(mm)	1400	1600	1600	1600	-	-	-	-	-	
	Genişlik **	b3	(mm)	-	1800	1800	1800	1800	1900	2400	2600	2600	
	Derinlik	d2	(mm)	1600	1600	1900	2600	2100	2300	2300	2300	2600	
KUYU DİBİ DERİNLİĞİ	Vn=0,63m/sn	d3	(mm)	1400	1400	1400	1400	1400	1400	1400	1600	1600	
	Vn=1,00m/sn	d3	(mm)	1400	1400	1400	1400	1400	1400	1400	1600	1600	
	Vn=1,60m/sn	d3	(mm)	-	1600	1600	1600	1600	1600	1600	1600	1600	
	Vn=2,50m/sn	d3	(mm)	-	-	2200	2200	-	2200	2200	2200	2200	
EN ÜST DURAK SEVİYESİ ÜSTÜNDEKİ YÜKSEKLİK	Vn=0,63m/sn	h1	(mm)	3600	3600	3600	3600	3800	3800	4200	4400	4400	
	Vn=1,00m/sn	h1	(mm)	3700	3700	3700	3700	3800	3800	4200	4400	4400	
	Vn=1,60m/sn	h1	(mm)	3800	3800	3800	3800	4000	4000	4200	4400	4400	
	Vn=2,50m/sn	h1	(mm)	-	-	5000	5000	-	5000	5200	5400	5400	
M A K İ N A D A İ R E S İ	ALAN	Vn=0,63m/sn	A	(m ²)	6	7,5	10	12	15	15	20	22	25
		Vn=1,00m/sn	A	(m ²)	6	7,5	10	12	15	15	20	22	25
		Vn=1,60m/sn	A	(m ²)	-	10	12	14	15	15	20	22	25
		Vn=2,50m/sn	A	(m ²)	-	-	14	16	-	18	20	22	25
	GENİŞLİK	Vn=0,63m/sn	h1	(mm)	1600	2200	2200	2400	2500	2500	3200	3200	3200
		Vn=1,00m/sn	h1	(mm)	1600	2200	2200	2400	2500	2500	3200	3200	3200
		Vn=1,60m/sn	h1	(mm)	-	2200	2200	2400	2500	2500	3200	3200	3200
		Vn=2,50m/sn	h1	(mm)	-	-	2800	2800	-	2800	3200	3200	3200
	DERİNLİK	Vn=0,63m/sn	d4	(mm)	3000	3200	3700	4200	3700	3700	4900	4900	5500
		Vn=1,00m/sn	d4	(mm)	3000	3200	3700	4200	3700	3700	4900	4900	5500
		Vn=1,60m/sn	d4	(mm)	-	3200	3700	4200	3700	3700	4900	4900	5500
		Vn=2,50m/sn	d4	(mm)	-	-	3700	4200	-	3700	4900	4900	5500
	YÜKSEKLİK	Vn=0,63m/sn	h2	(mm)	2000	2000	2000	2000	2200	2200	2400	2400	2800
		Vn=1,00m/sn	h2	(mm)	2000	2000	2000	2000	2200	2200	2400	2400	2800
		Vn=1,60m/sn	h2	(mm)	-	2200	2200	2200	2200	2200	2400	2400	2800
		Vn=2,50m/sn	h2	(mm)	-	-	2600	2600	-	2800	2400	2800	2800

* Sağa veya sola toplana teleskopik kapılı asansörler için

** Merkezden açılan kapılı asansörler için

320 ve 400 Kg taşıma kapasiteli asansörler özrürlü kişilerin tekerlekli sandalyede asansörü kullanmaları için uygun değildir.

Functional Dimensions of Human Elevators (Class I - II)

			HOUSES				BUSINESSES						
TRANSPORTATION CAPACITY			(Kg)	320	400	630	1000	630	800	1000	1250	1600	
LOAD OF REMEMBRANCE			(Person)	4	5	8	13	8	10	13	16	21	
CABIN AREA			(min)	0,79	0,98	1,45	2,15	1,45	1,73	2,15	2,57	3,245	
			(max)	0,95	1,17	1,66	2,4	1,66	2	2,4	2,9	3,56	
CABIN DIMENSIONS	Width	b1	(mm)	900	1100	1100	1100	1100	1350	1600	1950	1950	
	Depth	d1	(mm)	1000	1000	1400	2100	1400	1400	1400	1400	1750	
	Height		(mm)	2200	2200	2200	2200	2200	2200	2300	2300	2300	
STOP DOORS	Width	b2	(mm)	700	800	800	800	800	800	1100	1100	1100	
	Height	h3	(mm)	2000	2000	2000	2000	2000	2000	2100	2100	2100	
WELL DIMENSIONS	Width*	b3	(mm)	1400	1600	1600	1600	-	-	-	-	-	
	Width**	b3	(mm)	-	1800	1800	1800	1800	1900	2400	2600	2600	
	Depth	d2	(mm)	1600	1600	1900	2600	2100	2300	2300	2300	2600	
WELL BOTTOM DEPTH	Vn=0,63m/sn	d3	(mm)	1400	1400	1400	1400	1400	1400	1400	1600	1600	
	Vn=1,00m/sn	d3	(mm)	1400	1400	1400	1400	1400	1400	1400	1600	1600	
	Vn=1,60m/sn	d3	(mm)	-	1600	1600	1600	1600	1600	1600	1600	1600	
	Vn=2,50m/sn	d3	(mm)	-	-	2200	2200	-	2200	2200	2200	2200	
TOP STOP LEVEL HEIGHT ABOVE	Vn=0,63m/sn	h1	(mm)	3600	3600	3600	3600	3800	3800	4200	4400	4400	
	Vn=1,00m/sn	h1	(mm)	3700	3700	3700	3700	3800	3800	4200	4400	4400	
	Vn=1,60m/sn	h1	(mm)	3800	3800	3800	3800	4000	4000	4200	4400	4400	
	Vn=2,50m/sn	h1	(mm)	-	-	5000	5000	-	5000	5200	5400	5400	
E N G I N E R O O M	AREA	Vn=0,63m/sn	A	(m ²)	6	7,5	10	12	15	15	20	22	25
		Vn=1,00m/sn	A	(m ²)	6	7,5	10	12	15	15	20	22	25
		Vn=1,60m/sn	A	(m ²)	-	10	12	14	15	15	20	22	25
		Vn=2,50m/sn	A	(m ²)	-	-	14	16	-	18	20	22	25
	WIDTH	Vn=0,63m/sn	h1	(mm)	1600	2200	2200	2400	2500	2500	3200	3200	3200
		Vn=1,00m/sn	h1	(mm)	1600	2200	2200	2400	2500	2500	3200	3200	3200
		Vn=1,60m/sn	h1	(mm)	-	2200	2200	2400	2500	2500	3200	3200	3200
		Vn=2,50m/sn	h1	(mm)	-	-	2800	2800	-	2800	3200	3200	3200
	DEPTH	Vn=0,63m/sn	d4	(mm)	3000	3200	3700	4200	3700	3700	4900	4900	5500
		Vn=1,00m/sn	d4	(mm)	3000	3200	3700	4200	3700	3700	4900	4900	5500
		Vn=1,60m/sn	d4	(mm)	-	3200	3700	4200	3700	3700	4900	4900	5500
		Vn=2,50m/sn	d4	(mm)	-	-	3700	4200	-	3700	4900	4900	5500
HEIGHT	Vn=0,63m/sn	h2	(mm)	2000	2000	2000	2000	2200	2200	2400	2400	2800	
	Vn=1,00m/sn	h2	(mm)	2000	2000	2000	2000	2200	2200	2400	2400	2800	
	Vn=1,60m/sn	h2	(mm)	-	2200	2200	2200	2200	2200	2400	2400	2800	
	Vn=2,50m/sn	h2	(mm)	-	-	2600	2600	-	2800	2400	2800	2800	

* Right or left for telescopic door elevators

** For door lifts that open from the center

Elevators with a carrying capacity of 320 and 400 Kg are not suitable for disabled people to use the elevator in wheelchairs.

Hasta Asansörleri(Sınıf I-II) Fonksiyonel Boyutlar

TAŞIMA KAPASİTESİ			(Kg)	1600	2000	2500
KABİN ALANI			(min)	3,245	3,82	4,625
			(max)	3,56	4,2	5
KABİN EBATLARI	Genişlik	b1	(mm)	1400	1500	1800
	Derinlik	d1	(mm)	2400	2700	2700
	Yükseklik		(mm)	2300	2300	2300
DURAK KAPILARI	Genişlik	b2	(mm)	1300	1300	1300+
	Yükseklik	h3	(mm)	2100	2100	2100
KUYU EBATLARI	Genişlik	b3	(mm)	2400	2400	2700
	Derinlik	d2	(mm)	3000	3200	3300
KUYU DİBİ DERİNLİĞİ	Vn=0,63m/sn	d3	(mm)	1600	1600	1800
	Vn=1,00m/sn	d3	(mm)	1700	1700	1900
	Vn=1,60m/sn	d3	(mm)	1900	1900	2100
	Vn=2,50m/sn	d3	(mm)	2500	2500	2500
EN ÜST DURAK SEVİYESİ ÜSTÜNDEKİ YÜKSEKLİK	Vn=0,63m/sn	h1	(mm)	4400	4400	4400
	Vn=1,00m/sn	h1	(mm)	4400	4400	4600
	Vn=1,60m/sn	h1	(mm)	4400	4400	4600
	Vn=2,50m/sn	h1	(mm)	5400	5400	5600
MAKİNA DAİRESİ	ALAN	A	(m2)	25	27	29
	GENİŞLİK	b4	(mm)	3200	3200	3500
	DERİNLİK	d4	(mm)	5500	5800	5800
	YÜKSEKLİK	h2	(mm)	2800	2800	2800

Yük Asansörleri (Sınıf IV) Fonksiyonel Boyutlar

TAŞIMA KAPASİTESİ			(Kg)	630	1000	1600	2000
KABİN EBATLARI	Genişlik	b1	(mm)	1100	1300	1500	1500
	Derinlik	d1	(mm)	1400	1750	2250	2700
	Yükseklik		(mm)	2200	2300	2200	2200
DURAK KAPILARI	Genişlik	b2	(mm)	1100	1300	1500	1500
	Yükseklik	h3	(mm)	2100	2100	2100	2100
KUYU EBATLARI	Genişlik	b3	(mm)	2100	2400	2700	2700
	Derinlik	d2	(mm)	1900	2300	2800	3200
KUYU DİBİ DERİNLİĞİ	V<1,00m/sn	d3	(mm)	1500	1500	1700	1700
EN ÜST DURAK SEVİYESİ ÜSTÜNDEKİ YÜKSEKLİK	Vn<1,00 m/sn	h1	(mm)	4100	4100	4300	4300
MAKİNA DAİRESİ	ALAN	A	(m2)	12	14	18	20
	GENİŞLİK	b4	(mm)	2800	3100	3400	3400
	DERİNLİK	d4	(mm)	3500	3800	4500	4900
	YÜKSEKLİK	h2	(mm)	2200	2200	2400	2400

Servis Asansörleri (Sınıf V) Fonksiyonel Boyutlar

TAŞIMA KAPASİTESİ			(Kg)	40	100	250
KABİN EBATLARI	Genişlik	b1	(mm)	600	800	1000
	Derinlik	d1	(mm)	600	850	1000
	Yükseklik		(mm)	800	800	1200
KUYU EBATLARI	Genişlik	b3	(mm)	900	1100	1500
	Derinlik	d2	(mm)	800	1000	1200

Functional Dimensions of Patient Elevators (Class I-II)

TRANSPORTATION CAPACITY			(Kg)	1600	2000	2500
CABIN AREA			(min)	3,245	3,82	4,625
			(max)	3,56	4,2	5
CABIN DIMENSIONS	Width	b1	(mm)	1400	1500	1800
	Depth	d1	(mm)	2400	2700	2700
	Height		(mm)	2300	2300	2300
STOP DOORS	Width	b2	(mm)	1300	1300	1300+
	Height	h3	(mm)	2100	2100	2100
WELL DIMENSIONS	Width	b3	(mm)	2400	2400	2700
	Height	d2	(mm)	3000	3200	3300
WELL BOTTOM DEPTH	Vn=0,63m/sn	d3	(mm)	1600	1600	1800
	Vn=1,00m/sn	d3	(mm)	1700	1700	1900
	Vn=1,60m/sn	d3	(mm)	1900	1900	2100
	Vn=2,50m/sn	d3	(mm)	2500	2500	2500
TOP STOP ON YOUR LEVEL HEIGHT	Vn=0,63m/sn	h1	(mm)	4400	4400	4400
	Vn=1,00m/sn	h1	(mm)	4400	4400	4600
	Vn=1,60m/sn	h1	(mm)	4400	4400	4600
	Vn=2,50m/sn	h1	(mm)	5400	5400	5600
ENGINE ROOM	AREA	A	(m ²)	25	27	29
	WIDTH	b4	(mm)	3200	3200	3500
	DEPTH	d4	(mm)	5500	5800	5800
	HEIGHT	h2	(mm)	2800	2800	2800

Load Elevators (Class IV) Functional Dimensions

TRANSPORTATION CAPACITY			(Kg)	630	1000	1600	2000
CABIN DIMENSIONS	Width	b1	(mm)	1100	1300	1500	1500
	Depth	d1	(mm)	1400	1750	2250	2700
	Height		(mm)	2200	2300	2200	2200
STOP DOORS	Width	b2	(mm)	1100	1300	1500	1500
	Height	h3	(mm)	2100	2100	2100	2100
WELL DIMENSIONS	Width	b3	(mm)	2100	2400	2700	2700
	Depth	d2	(mm)	1900	2300	2800	3200
WELL BOTTOM DEPTH	V<1,00m/sn	d3	(mm)	1500	1500	1700	1700
TOP STOP ON YOUR LEVEL HEIGHT	Vn<1,00 m/sn	h1	(mm)	4100	4100	4300	4300
ENGINE ROOM	AREA	A	(m ²)	12	14	18	20
	WIDTH	b4	(mm)	2800	3100	3400	3400
	DEPTH	d4	(mm)	3500	3800	4500	4900
	HEIGHT	h2	(mm)	2200	2200	2400	2400

Service Elevators (Class V) Functional Dimensions

TRANSPORTATION CAPACITY			(Kg)	40	100	250
CABIN DIMENSIONS	Width	b1	(mm)	600	800	1000
	Depth	d1	(mm)	600	850	1000
	Height		(mm)	800	800	1200
WELL DIMENSIONS	Width	b3	(mm)	900	1100	1500
	Depth	d2	(mm)	800	1000	1200

ELEVATOR INQUIRY FORM (ELECTRICAL)

Customer Information

 Contact :
 Company :
 Address :

 Phone :
 Fax :
 Project Name :

TECHNICAL SPECIFICATION

Area

 Usage Area Passenger Bed Car Panoramic
 Fright-Goods Dumbwaiter Disabled

 Machine Room Above Bottom Side Roomless

Shaft Depth _____ mm

Shaft Width _____ mm

Pit Depth _____ mm

Travel Distance _____ mm

Last Floor _____ mm

Floor Height _____ mm

Floor/ Stop _____

 Suspension 1:1 2:1 3:1 4:1

 Motor Type Geared Gearless

Capacity _____ kg

Speed _____ m/s

 Door Type Automatic Semi-Automatic

Door Dimensions _____ mm x mm

 Door Design S. Steel Golden DecoStyle

 RAL Painted Glass Laminated

 Door Operation Central Opening Telescopic

 Cabin Design S. Steel Golden DecoStyle

 RAL Painted Glass Laminated

 Cabin Floor Type Granite PVC Aluminium

Cabin Model _____ (Choose from our Catalogue)

No of entrances _____ 0,1,2,3,4,5,6 ...

Entrance Height _____ mm

 Landing Button-LOP Digital Dotmatrix LCD

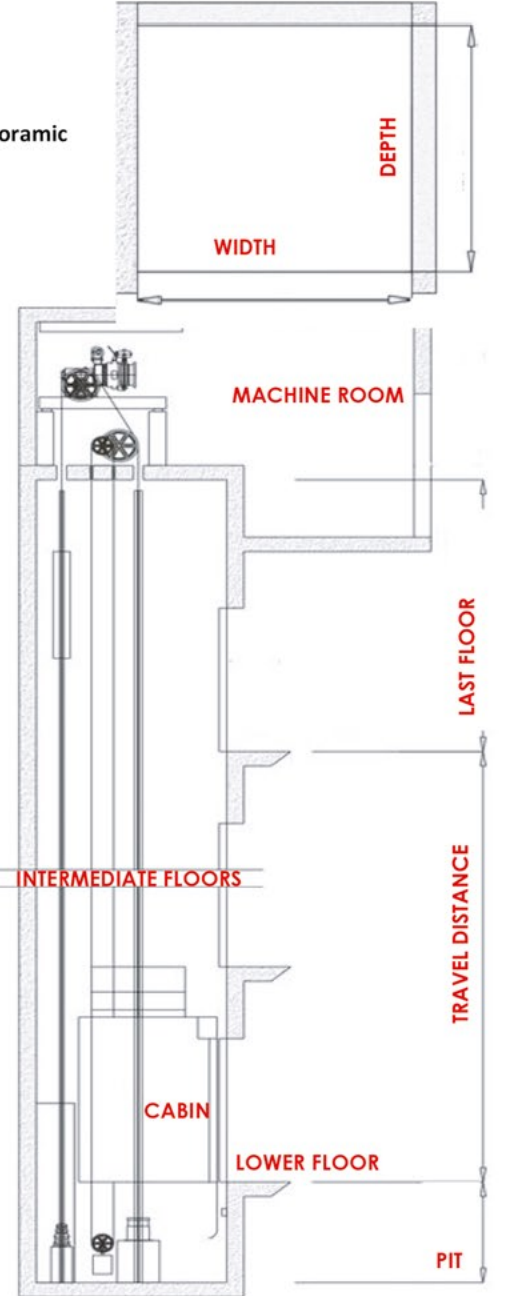
 Car Button-COP Digital Dotmatrix LCD

NOTE :

HİDOKS ASANSÖR İnşaat Makine San. Ltd. Şti.

 Fevzi Çakmak Mah. 10728.Sk. No:5
 Karatay / KONYA / TÜRKİYE

 Tel +90 332 237 66 55
 Faks +90 332 238 91 00

 E-Posta bilgi@hidoks.com.tr
 Web www.hidoks.com.tr





Hidoks Asansör İnşaat Makine San. Ltd. Şti.

FABRİKA : Fevzi Çakmak Mah.
Konsan San. Sit. 10728 Sk. No:5
KONYA / TÜRKİYE

TEL : +90 (332) 237 66 55
FAKS : +90 (332) 238 91 00

KULU ŞUBE : Yeni Mahallesi
Ayyıldız Sit. Kızılay Apt. No: 1/2
KULU / KONYA

TEL : +90 (332) 641 42 00
GSM : +90 (544) 650 25 16

www.hidoks.com.tr
bilgi@hidoks.com.tr